

# Collections



## Who we are

Steelite International is a world leading manufacturer and supplier of award winning tabletop and buffet products for the hospitality industry. Listening to our customers has allowed us to offer innovative solutions in ceramic, metal, glass, wood and melamine. Servicing over 140 countries, we are committed to offering the best in functionality and design, while minimising the effect on our environment.

Customer satisfaction requires dedication, commitment and a passion to achieve levels of excellence far exceeding expectation. The following pages contain a carefully and deliberately selected collection of ceramics, glassware, cutlery, accessories and more presented by Steelite International in an effort to satisfy this objective. Collections offers a custom look for any tabletop. Discover your opportunities with Distinction and Performance and realise the endless possibilities with our numerous partners in excellence.

We look forward to serving you!





## Showrooms

Steelite Showrooms provide the perfect opportunity to explore our vast portfolio, and our knowledgeable sales team will offer a solution for any tabletop concept. We are proud to have showrooms in these locations:

### UK

Stoke-on-Trent  
London

### EU

Bickenbach, Germany

### AUS

Sydney

### US

Atlanta, Georgia  
Chicago, Illinois  
Cincinnati, Ohio  
Los Angeles, California  
Las Vegas, Nevada  
New York, New York  
Washington, D.C.  
Youngstown, Ohio

### CA

Toronto, Ontario

## A truly global enterprise

With a wide range of products, Steelite offers a unique solution for any venue. Dominating nearly every industry sector from commercial catering to leisure and hospitality markets, the opportunities are endless with our vast product portfolio. Our core dinnerware lines, Distinction and Performance, and proprietary brands, Creations, Folio and Varick, are complemented by collections from strategically chosen specialist partners.

### Our brands



### Our partners

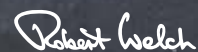

# Contents

## Introduction

Welcome .....8  
 Testimonials .....15

## Products

### Alumina Vitrified .....24

- **Distinction** .....26
  - Willow ●● .....28 (F)
  - Monaco .....36 (F)
  - Axis .....39 (I)
  - Float ● .....39 (I)
  - Sheer .....40 (I)
  - Quadro .....40 (I)
  - Neo .....40 (I)
  - Contour .....40 (I)
  - Koto .....42 (I)
  - Antoinette .....44 (F)
  - Spyro .....46 (F)
  - Organics ● .....48 (F)
  - Alvo .....50 (F)
  - Bianco .....52 (F)
- **Performance** .....54
  - Craft .....56 (F)
  - Craft Cookware .....62 (I)
  - Craft Melamine ● .....64 (F)
  - Scape ●● .....66 (F)
  - Ink .....70 (F)
  - Charcoal Dapple .....72 (F)
  - Brown Dapple .....74 (F)
  - Blue Dapple .....76 (F)
  - FreeStyle .....78 (I)
  - Taste .....80 (F)
  - Taste Squares & Rectangles .....82 (F)
  - Taste Glass ● .....83 (F)
  - Terramesa .....84 (F)
  - Simplicity .....86 (F)
  - Simplicity Cookware .....90 (I)
  - LiV .....92 (F)
  - Rio .....94 (F)
  - Carnival .....95 (F)
  - Freedom ●● .....96 (F)

- **Accessories** .....98
  - Creations Wood .....98 (I)
  - Stage .....100 (F)
  - Creations Glassware .....101 (I)

- **Bone China** .....102
  - Royal Crown Derby** .....104
    - Art Glaze .....106 (F)
    - Studio Glaze .....108 (F)

- **Stoneware** .....110
  - Anfora** .....112
    - Alma .....112 (F)
    - Puebla .....114 (F)

- **Porcelain** .....116
  - Robert Gordon** .....118
    - The Potters Collection .....120 (F)
  - Rene Ozorio** .....122
    - Wabi Sabi .....124 (F)
    - Sonata .....128 (F)
    - Aura .....130 (F)
    - Accessories .....133
  - Crucial Detail** .....134
    - Plateau .....136 (I)
    - Buffet .....137 (I)
    - Landscape .....138 (I)
    - Parentheses .....139 (I)
  - Varick** .....140
    - Café Porcelain .....140 (I)

- **Cutlery** .....142
  - Folio** .....144 (F)
  - Hartman .....146 (F)
  - Alison .....147 (F)
  - Bryce .....148 (F)
  - Pirouette .....149 (F)
  - Varick** .....150 (F)
  - Marnee .....152 (F)
  - Avina .....153 (F)
  - Distressed Briar .....154 (F)
  - Fulton Vintage Copper .....155 (F)
  - Fulton Vintage .....156 (F)
  - Origin .....157 (F)
  - Steak Knives .....158 (F)
  - Jean Dubost** .....160 (F)
  - Laguiole .....160 (F)

- **Cutlery** ..... 142
- Robert Welch** ..... 162 
- Baguette ..... 164 
- Bud ..... 166 
- Honeybourne ..... 168 
- Kingham ..... 170 
- Malvern ..... 172 
- Radford ..... 174 
- RW2 ..... 178 
- Stanton ..... 180 
- Steak Knives ..... 182 
- Trattoria ..... 184 
- Drift ..... 186 
- Accessories ..... 188 
- Signature ..... 190 
  
- **Glassware** ..... 194
- Drinique** ..... 196 
- Elite ..... 198 
- Caliber ..... 200 
- Thrill** ..... 201 
- Vortex ..... 201 
  
- **Buffet Service &**
- Presentation** ..... 202
- Catherine Hurand** ..... 204
- Creations Glassware** ..... 208
- Creations** ..... 218
- Display Stands ..... 218
- Williamsburg Metalworks** ..... 220
- Seafood Stands ..... 220
- Oak & Ford** ..... 222
- Roselli** ..... 224
- Castle Chafer** ..... 226
- Canyon Chafers** ..... 228
- Melamine** ..... 230
- Creations ..... 232
- Elite Global Solutions ..... 242
  
- **Index** ..... 252

 **Foundation**  
Choose pieces from these ranges to set the tone and style of your tabletop.

 **Innovation**  
Use pieces from these ranges to create signature dishes or to help with menu day-parting.

 **Cutlery**  
Choose from our suggested ranges to complement your tabletop with the perfect cutlery match.

 **Glassware**  
Complete your tabletop solution with glassware that combines perfectly with your chosen tableware.

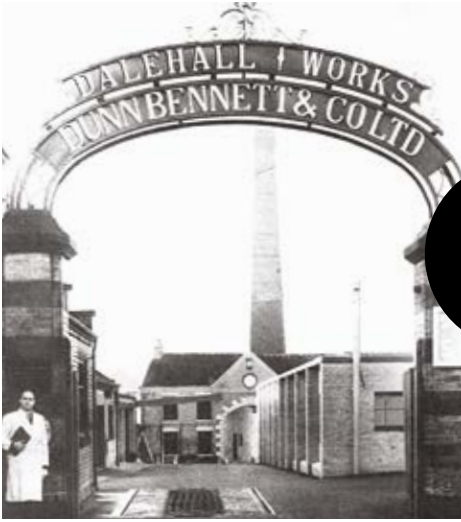

**100+**  
**YEARS**  
since 1875



1968 - 2018  
**50<sup>th</sup>**  
ANNIVERSARY  
VITRIFIED PLATE



**140+**  
**COUNTRIES**



**UK**  
**MANUFACTURING**



**1000+**  
**EMPLOYEES**



**RECORD**  
**BREAKING**  
**GROWTH**



**HIGHLY SKILLED**  
**CRAFTSPEOPLE**

# Welcome

Steelite International is a world-leading manufacturer of award-winning inspirational tabletop for the international hospitality industry, with a manufacturing history at its current site in Stoke-on-Trent going back more than 100 years. As one of the most modern and efficient tableware production units in the world, our investment in technology and innovation guarantees a quality product.



reddot award 2017  
winner



THE SENTINEL  
BUSINESS  
AWARDS

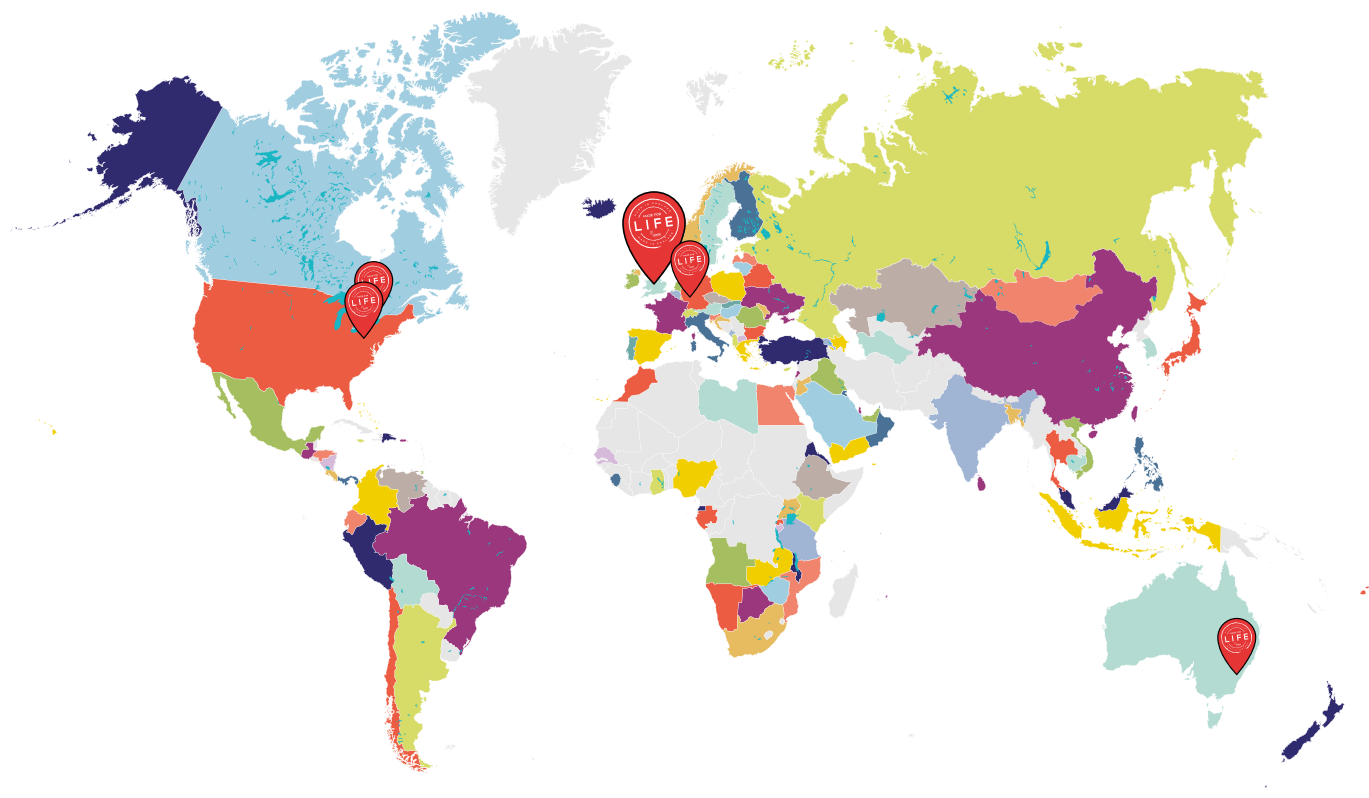

# A Journey Through The Years



2001

11th September - An order was received from the 'Windows on the World' Restaurant on the top floor of the World Trade Centre. At 1.45pm UK time, it was destroyed by terrorists.



1998

First robot installed in the aerographing department.

Export sales exceeded home sales volume for the first time.



1995



Steelite International USA Inc and Steelite International Canada Ltd were formed.



1991



1983

Hotelware division of Royal Doulton Acquired. Mr David Edward Dunn Johnson bought the whole hotelware division from Royal Doulton. Steelite International plc was formed.



1968

Steelite vitreous body created.



Dunn Bennett & Co Ltd was acquired by Doulton & Co and became the Hotelware Division of Royal Doulton.



1974

'Steelite is internationally acclaimed for toughness with elegance' within the Hotel and Restaurant industry.



1911

The Company equipped Scott's ill-fated expedition to the South Pole free of charge, in return for being able to advertise the tableware as being durable and tough.

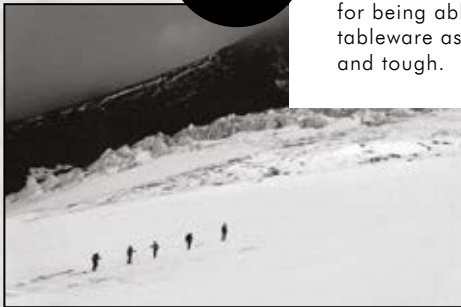

1937

Dalehall works (present location) was acquired and gradually modernised.



1875

In 1875 Thomas Wood Bennett who invented the reinforced edge, created his factory of hotel porcelain. Dunn Bennett was founded by William Dunn (master potter) and Thomas Wood Bennett (an ambitious salesman).



THE SKY'S THE LIMIT

1968 - 2018  
**50<sup>th</sup>**  
 ANNIVERSARY  
 VITRIFIED PLATE

The company currently employs over 750 people and has an annual turnover of circa £50m.

2007



Made for Life campaign launched.

Steelite International awarded Gold Green Apple award for Lamella project.

2018



Launch of the new flagship London showroom.

2010



Launch of Lifetime Edge Chip Warranty on Distinction & Performance ranges, extending our commitment to quality products.



Willow wins the prestigious RedDot design award.

Major new product launches including Willow and Scape.

2017



Acquired the iconic British brand Royal Crown Derby.

2012

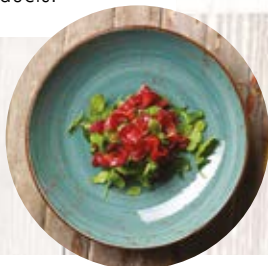

Craft range wins Innovator Award at Star Chef's International Chefs Congress in New York.



2016

2016



Nominated for a European Business Award.

2015

Record results for 6th year running.



Record results for 5th year running.

Honoured with Queen's Award for Enterprise in the International Trade category.

2013



First combined exhibition platform for Steelite International and Royal Crown Derby.

First degree programme students graduate.

Record results for 3rd year running.



First tableware manufacturer certified as 'Approved Supplier' to the hospitality industry by the Sustainable Restaurant Association.

Steelite International celebrate 30th anniversary since becoming independent in 1983.

Record results for 4th year running.

2014



Opening of new Dish Cell.

Craft wins Product Excellence Award – The Caterer.





Our Made in England – Made for Life campaign promotes the benefits of British manufactured tableware, and underpins the four elements of our mission statement.

This is our commitment to you. We make our products and serve our customers with this in mind – everything we deliver is for life.



INSPIRATIONAL DESIGN

We design our products for life.



EXCELLENT QUALITY

We make our products for life.



OUTSTANDING SERVICE

Our customers are partners for life.



MINIMISING ENVIRONMENTAL IMPACT

We are helping secure an environment that is fit for life.

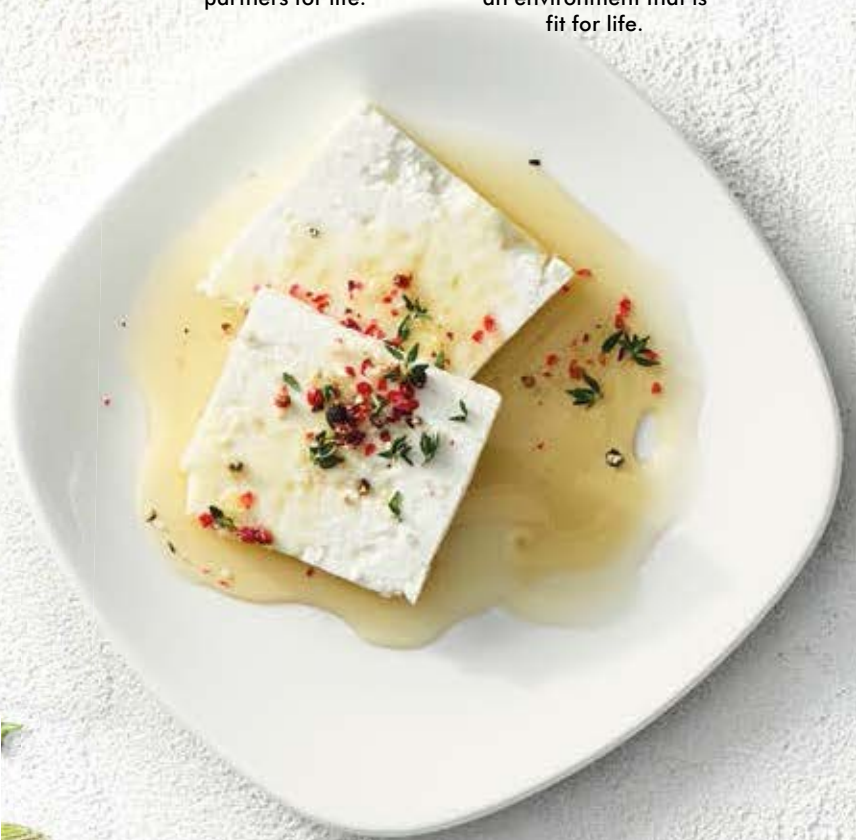

★ LIFETIME ★  
**EDGE CHIP WARRANTY**  
 YOUR CONFIDENCE ASSURED

The Steelite International Lifetime Edge-Chip Warranty is your assurance that all Distinction and Performance products manufactured in the UK factory will withstand the rigours of the modern commercial kitchen and remain chip free.



# Steelite International Products

## Alumina Vitrified 24

Manufactured to exacting standards in our factory in Stoke-on-Trent, our Alumina Vitrified ranges provide style and elegance in product with excellent performance, functionality and durability.



### Distinction

The Distinction ranges bring elegance and excitement to the tabletop, whilst maintaining superb, lasting durability.



### Performance

Ranges within Performance combine presentation with practicality. They comprise smart, functional and affordable pieces that are specifically designed to withstand everyday, intensive use within a commercial environment.

Both Distinction and Performance ranges are Made for Life and every piece is covered by our unique Lifetime Edge-Chip Warranty, so your confidence is assured.



## Bone China 102

Bone China is a soft paste porcelain, very fine and translucent which was first made in England in 1645. Our range offered under the umbrella of

Royal Crown Derby represents a vision to create tableware as a luxury statement for use in fine restaurants and hotels around the world.



## Stoneware 110

The Anfora collection is designed specifically for casual, fast paced establishments. Offering an unrivalled combination of value, exceptional durability and good looks.



## Porcelain 116

The Porcelain ranges from Robert Gordon, Rene Ozorio, Crucial Detail and Varick are uniquely designed offers, which bring a sensational added dimension to the dining experience.



## Cutlery 142

With Folio, Varick, Laguiole and Robert Welch our specialist partners, we have designers of fine cutlery who perfectly mirror our own exacting standards.



## Glassware 194

Steelite International shares a passion for perfection with Drinique, a company dedicated to producing the very best glassware. Stack them without sticking, wash them without cracking, and even drop them without breaking.



## Buffet, Service & Presentation 202

An increasingly exciting dining occasion, buffet requires product which is versatile and elegant whilst retaining practicality. New and existing offers maximise this opportunity and help create dynamic displays, as well as offering exciting new twists on classic lines.

# Environmental Credentials

Steelite International work closely with a number of suppliers and organisations, and are continually monitoring, developing and improving procedures to create minimum impact on the community and environment, while ensuring maximum efficiency and cost savings for the future sustainability of the business.

Steelite International is a member of The Green Organisation that rewards and promotes environmental best practice around the world, and the Staffordshire Business & Environmental Network, which aims to help local businesses reduce environmental impacts while also generating profits.

We have a dedicated and innovative approach to caring for the environment. In 2007, the business became one of only five companies in the UK to install a Lamella system. Steelite is the only tableware manufacturer to use a Lamella system for recycling clay waste.

In addition to clay recycling, fewer chemicals are now required to separate waste. This has a positive effect on the environment and water discharged from the site is also purer.



**The Lamella has significantly reduced Steelite International's impact on the environment. The company now recycles in excess of 90% of manufacturing waste. In 2010 we received a Green Apple Award for the Lamella project.**

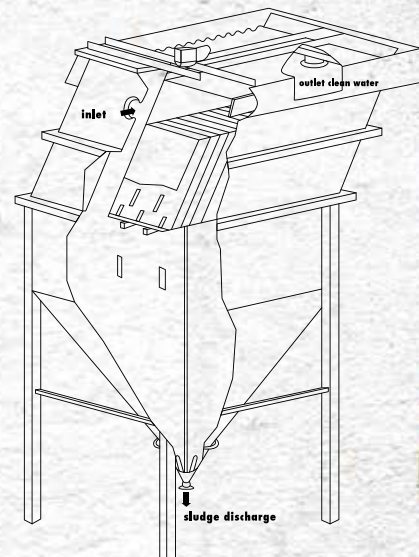



### ASMA KHAN FOUNDER • Darjeeling Express, London UK

Darjeeling Express started as a dinner for 12 guests at home, serving Indian food lovingly cooked from family recipes that go back generations. "I wanted the plates to be a frame for my food - the brown dappled edge was exactly what I wanted and Steelite kindly made a range bespoke for me - and added the logo too. One of our starter dishes - the chilli garlic prawns is heavily instagrammed - the bespoke Steelite plate the perfect background! So happy I spent time and resources on my tableware - every time I walk into my restaurant and see the tables set up for service my heart smiles - I am still so in love with the plates one year since we opened."

TESTIMONIALS



**SIMON HULSTONE CHEF PROPRIETOR • The Elephant, Torquay UK**

The restaurant offers a delicious à la carte menu and set menus featuring fish, meat and vegetables all sourced locally from the surrounding area. Diners looking for something extra special can select the Michelin starred tasting menu. All dishes served at The Elephant change regularly depending on the locally grown and reared ingredients that are best. Many of these are sourced from their dedicated farm. "Steelite have really come up trumps again with Scape, as with continuing trends in food changing all the time Steelite have matched chefs expectations and produced a range that will lead the way and be seen in the worlds best kitchens. Scape is so versatile for the chef it can be showcased from high end establishments."



**RYAN CLIFT CHEF/OWNER OF TIPLING CLUB, SINGAPORE • Masterpieces event, Dubai UAE**

Often described as a 'gastronomic superstar' British born Ryan Clift has achieved a lot during his career. In early 2008, Ryan moved to Singapore to start his own venture, determined to take modern food and cocktail pairing to a new level. "Masterpieces was a magnificent opportunity to share my own interpretations of unique and traditional dishes with a great audience. Thank you Steelite International."

TESTIMONIALS



**GUSTAF SANDFRIDSSON HEAD CHEF • The Brasserie, Stockholm Sweden**

The Brasserie is a restaurant where the flavours are characterised by Scandinavian craftsmanship and a huge passion for food. Here, local produce and Nordic flavours are the menu's thread. Located within the Royal Opera building the Brasserie opened its doors in 2015 after a careful renovation of the Opera building. "Working with plates from Steelite gives me the opportunity to choose what I think the dish deserves to be presented. Even a plate can be the first idea of a new dish that you can continue with."



### IACOPO VANNINI CHEF PATRON • Restaurant Villa Garzoni, Collodi Italy

The restaurant Villa Garzoni can be found in Collodi, the province of Pistoia revealing a perfect blend between the Tuscan traditional flavours and the innovation of contemporary cuisine, in a picturesque location. "There are moments in life when you meet someone for the first time and you feel you already know them. When I saw Steelite for the first time I was speechless, I knew I had found what I was looking for. I will continue to use Steelite for the rest of my professional life."

TESTIMONIALS



**GENI PERRAMÓN CHEF • The Tavern of the Gourmet, Alicante Spain**

The Tavern of the Gourmet is a space where innovation is at the heart of service. Organic and traditional flavours, succulent tapas and montaditos, and salted cheese are prepared in a lively bar using the highest quality ingredients. The Tavern of the Gourmet is an example of the basic pillars of good cuisine: the best products, nice, comfortable space and professionalism. A gastronomic space that you must stop and visit. "Steelite is synonymous with bringing elegance to our tables. Excellent durability and service from the factory, also a lifetime edge chip warranty gives us peace of mind."



**JASON HALL EXECUTIVE CHEF • Legasea Seafood Brasserie at Moxy Hotel, TAO Group New York, NY**

At RCP/Williamsburg Metal, Connie and her shop allow for detailed customization, mixing in old world charm with modern aesthetic. We chose Robert Gordon Pottery at Legasea because of its handmade feel and durability. Its Australian-designed pattern gives a unique feel to our restaurant.

TESTIMONIALS



**GAYLE TALMA** GROUP OPERATIONS DIRECTOR • **Elegant Hotels Group Barbados**

Elegant Hotels Group has worked with Steelite for over 20 years, and every year we are more impressed with their innovation, versatility and certainly the durability of their products. With eight boutique hotels and over 12 restaurants, Steelite allows us to craft a different culinary narrative that complements each restaurant's unique personality and character, without ever having to compromise on quality. Their sophisticated, elegant and eclectic designs have elevated our food presentation and provide the perfect canvas for our Chefs to express their creativity.



**KIMBERLY LALLOUZ CHEF • Restaurant Monsieur Montreal, Quebec**

Steelite is everywhere around me – it's in all of my restaurants, in most of my photoshoots, and even my #1 choice for international competition plates. From Birdbar's laid-back fried chicken and champagne comfort dishes to Restaurant du MAC & Monsieur Resto+Bar more delicate and soignée plates. I love the variety, durability and look of the brand; there's something for everyone from the various lines that are offered. Customer service and client support are bar none, so it's a true pleasure for me to work with the reps and products alike every season.

# ALUMINA VITRIFIED

The Distinction and Performance ranges manufactured in Stoke-on-Trent from our Alumina Vitrified clay body offer our customers the opportunity to purchase sleek and elegant pieces with the security of durability and lasting product excellence.







# DISTINCTION

## Outward beauty, inner strength

The range of tableware within the Distinction collection offers both beauty and strength. Exuding elegance and class, each piece boasts superior strength for lasting durability, allowing you to create truly memorable dining experiences time after time.

## A new standard in tableware

- high alumina vitrified clay body for long lasting performance and durability
- an extensive collection of shapes, patterns and colours
- both traditional and trendsetting designs
- rim on rim stacking
- fully glazed foot
- microwave, oven and freezer safe
- Lifetime Edge Chip Warranty

We want you to be as confident in our product as we are, which is why we continue to stand by our worldwide Lifetime Edge Chip Warranty. Applicable to all items manufactured as part of our Distinction range, the warranty covers each item for life.

## Steelite International

unparalleled design, unrivalled durability





**woven white wonderful**

Exuding style and hidden strength, the Willow collection is perfect for all fine dining and banqueting environments. Offering multi-level presentations through a series of wide rim gourmet plates and a new modern mid rim plate, Willow provides an elevated presentation that will withstand the demands of a robust commercial environment. Stylish and pure glass pieces in clear and smoked offer further dimensions and presentation opportunities for fine dining. The addition of two rich colour glazes, which create a jewel like effect add further beauty to this range. The glazes highlight and pick up the beauty of the embossed design, and elevate the Willow presentation of key signature items.

Patterns Available



In 2017 the Willow collection was awarded the sought-after Red Dot seal of approval for outstanding design.



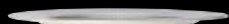

**NEW**

Gourmet Plate Large Well  
C1170 28.5cm (11¼")



**NEW**

Gourmet Plate Medium Well  
C1171 28.5cm (11¼")



**NEW**

Gourmet Plate Small Well  
C1172 28.5cm (11¼")



**NEW**

Gourmet Plate Accent  
C1177 18.5cm (7¼")



**NEW**

Gourmet Coupe Plate  
C1173 28.0cm (11")



**NEW**

Gourmet Rimmed Coupe Bowl  
C1174 28.5cm (11¼")  
89.0cl (31.3oz)



**NEW**

Gourmet Deep Coupe Bowl  
C1175 28.0cm (11")



**NEW**

Gourmet Deep Rimmed Bowl  
C1176 28.5cm (11¼")  
95.0cl (33.4oz)



**NEW**  
Gourmet Plate Large Well  
C1170 28.5cm (11¼")



**NEW**  
Gourmet Plate Medium Well  
C1171 28.5cm (11¼")



**NEW**  
Gourmet Plate Small Well  
C1172 28.5cm (11¼")



**NEW**  
Gourmet Plate Accent  
C1177 18.5cm (7¼")



**NEW**  
Gourmet Coupe Plate  
C1173 28.0cm (11")



**NEW**  
Gourmet Rimmed Coupe Bowl  
C1174 28.5cm (11¼")  
89.0cl (31.3oz)



**NEW**  
Gourmet Deep Coupe Bowl  
C1175 28.0cm (11")



**NEW**  
Gourmet Deep Rimmed Bowl  
C1176 28.5cm (11¼")  
95.0cl (33.4oz)





Gourmet Plate  
Large Well  
C1170 28.5cm (11¼")



Gourmet Plate  
Medium Well  
C1171 28.5cm (11¼")



Gourmet Plate  
Small Well  
C1172 28.5cm (11¼")



Gourmet Plate Accent  
C1177 18.5cm (7¼")



Gourmet Coupe Plate  
C1173 28.0cm (11")



Mid Rim Plate  
C1180 30.0cm (11¾")  
C1181 27.0cm (10<sup>5</sup>/<sub>8</sub>")  
C1182 25.5cm (10")  
C1183 23.0cm (9")  
C1184 20.25cm (8")  
C1185 15.75 (6¼")



Oval Plate  
C1190 33.0cm (13")



Mid Rimmed Bowl **NEW**  
C1214 24.0cm (9½")  
34.0cl (12oz)



Gourmet Rimmed  
Coupe Bowl  
C1174 28.5cm (11¼")  
89.0cl (31.3oz)



Gourmet Deep  
Coupe Bowl  
C1175 28.0cm (11")



Gourmet Deep  
Rimmed Bowl  
C1176 28.5cm (11¼")  
95.0cl (33.4oz)



Deep Rimmed Bowl  
C1191 31.5cm (12½")  
131.25cl (46.2oz)



Bowl **NEW**  
C1211 16.0cm (6¼")  
77.0cl (27oz)  
C1212 13.0cm (5¼")  
40.0cl (14oz)  
C1215 11.5cm (4½")  
28.5cl (10oz)  
C1213 10.0cm (4")  
18.5cl (6½oz)



Bowl  
C1210 16.5cm (6½")  
51.0cl (18oz)



Soup Cup Unhandled  
Stacking  
C1202 28.5cl (10oz)



Saucer  
C1192 15.25cm (6")



Saucer **NEW**  
C1193 11.75cm (4<sup>5</sup>/<sub>8</sub>")



Cup Stacking **NEW**  
C1205 8.5cl (3oz)



Cup Stacking  
C1200 21.25cl (7½oz)



Can Cup  
C1201 22.75cl (8oz)



Beverage Pot **NEW**  
C1206 60.0cl (21oz)  
C1207 Lid



Beverage Pot **NEW**  
C1208 45.5cl (16oz)  
C1207 Lid



Mug  
C1203 28.5cl (10oz)



Jug  
C1204 14.25cl (5oz)





**creations**  
BY STEELITE

CREATIONS  
**WILLOW GLASS™**



NEW

Gourmet Plate Medium Well  
B445 27.0cm (10<sup>5</sup>/<sub>8</sub>"

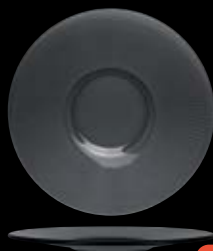

NEW

Gourmet Plate Small Well  
B446 27.5cm (10<sup>7</sup>/<sub>8</sub>"



NEW

Gourmet Coupe Plate  
B447 27.25cm (10<sup>3</sup>/<sub>4</sub>"

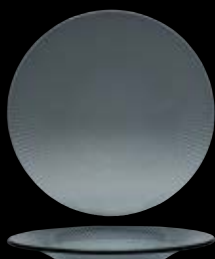

NEW

Gourmet Rimmed Coupe Bowl  
B448 27.25cm (10<sup>3</sup>/<sub>4</sub>"



NEW

Gourmet Deep Coupe Bowl  
B449 26.0cm (10<sup>1</sup>/<sub>4</sub>"



NEW

Gourmet Deep Rimmed Bowl  
B450 27.25cm (10<sup>3</sup>/<sub>4</sub>"

Due to the manufacturing process sizes may vary.

CLEAR: 6150

SMOKED: 6151



### stylish sophisticated smooth

A range of stylish shapes with the inner strength of Steelite International's Distinction formula to provide a remarkably versatile range that will complement any dining occasion. From the simplicity of Monaco White to the sophistication of Antoinette, Monaco provides a solution for all environments and can be used alongside any Distinction whiteware range.



**Wide Rim Plate**

- C1060 32.0cm (12½")
- C1061 29.0cm (11½")
- C1062 25.5cm (10")
- C1063 15.75cm (6¼")



**Flat Rim Plate**

- C307 32.0cm (12½")
- C300 30.5cm (12")
- C301 27.0cm (10<sup>5</sup>/<sub>8</sub>")
- C302 25.5cm (10")
- C303 23.0cm (9")
- C304 20.25cm (8")
- C305 15.75cm (6¼")



**Plate Vogue (Coupe)**

- C356 32.0cm (12½")
- C357 30.0cm (11¾")
- C358 27.0cm (10<sup>5</sup>/<sub>8</sub>")
- C359 25.5cm (10")
- C360 23.0cm (9")
- C361 20.25cm (8")
- C362 16.5cm (6½")



**Presentation Plate**

- C347 30.5cm (12")



**Oval Plate Vogue**

- C392 33.0cm (13")
- C393 28.0cm (11")
- C394 20.25cm (8")



**Crescent Salad**

- C063 20.25cm (8")



**Oval Plate**

- C345 33.0cm (13")
- C341 28.0cm (11")
- C339 20.25cm (8")

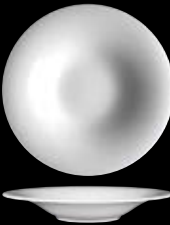

**Gourmet Rimmed Coupe Bowl**

- C1153 28.5cm (11¼")
- 28.5cl (10oz)



**Ultimate Bowl**

- C344 30.0cm (11¾")
- 159.0cl (56oz)



**Pasta Dish**

- C350 30.0cm (11¾")
- 56.75cl (20oz)



**Soup Plate**

- C310 22.25cm (8¾")
- 34.75cl (12.2oz) well



**Nouveau Bowl**

- C365 30.0cm (11¾")
- 52.5cl (18½oz) well
- C372 27.0cm (10<sup>5</sup>/<sub>8</sub>")
- 35.75cl (12.6oz) well
- C377 23.0cm (9")
- 21.25cl (7½oz) well



**Soup/Pasta**

- C363 24.0cm (9½")
- 42.0cl (14.8oz)



**Bowl**

- C247 15.9cm (6¼")
- 80.25cl (28oz)
- C242 12.7cm (5")
- 45.75cl (16oz)
- C248 11.2cm (4½")
- 25.5cl (9oz)
- C249 10.3cm (4")
- 20.0cl (7oz)
- C240 9.4cm (3¾")
- 12.75cl (4½oz)



**Bowl**

- C396 15.25cm (6")
- 72.5cl (25.5oz)
- C251 13.0cm (5¼")
- 48.3cl (17oz)
- C254 10.0cm (4")
- 20.0cl (7oz)



**Rim Fruit**

- C330 16.5cm (6½")
- 24.5cl (8.6oz)
- C329 13.5cm (5¼")
- 13.0cl (4.6oz)



**Dish Large**

- C245 10.5cm (4")
- 8.5cl (3oz)



**Dish Small**

- C246 7.0cm (2¾")
- 3.25cl (1¼oz)



**Bowl**

- C326 16.5cm (6½")
- 45.5cl (16oz)



**Saucer**  
**C318** 15.25cm (6")  
**C317** 11.75cm (4<sup>5</sup>/<sub>8</sub>")



**Fine Saucer**  
**C168** 16.5cm (6<sup>1</sup>/<sub>2</sub>")  
**C167** 11.75cm (4<sup>5</sup>/<sub>8</sub>")



**Rococo Can Saucer**  
**C1115** 16.5cm (6<sup>1</sup>/<sub>2</sub>")  
**C1117** 12.0cm (4<sup>5</sup>/<sub>8</sub>")  
 Saucers can be used as small plates.



**Rococo Can Cup**  
**C1114** 22.75cl (8oz)



**Rococo Can Cup**  
**C1116** 12.0cl (4oz)



**Fine Cup**  
**C174** 34.0cl (12oz)  
**C173** 22.75cl (8oz)  
**C172** 8.5cl (3oz)



**Cup Stacking**  
**C331** 21.25cl (7<sup>1</sup>/<sub>2</sub>oz)  
**C332** 17.0cl (6oz)  
**C333** 8.5cl (3oz)



**Low Cup**  
**C152** 34.0cl (12oz)  
**C189** 22.75cl (8oz)  
**C184** 17.0cl (6oz)  
**C190** 8.5cl (3oz)



**Tall Cup**  
**C338** 22.75cl (8oz)



**Tall Cup Unhandled**  
**C355** 8.5cl (3oz)



**Mug**  
**C334** 23.75cl (8<sup>1</sup>/<sub>2</sub>oz)



**Beaker Stacking**  
**C399** 26.0cl (9oz)



**Atlantic Mug**  
**C183** 34.0cl (12oz)



**Vogue Mug**  
**C686** 22.75cl (8oz)  
**C687** 28.5cl (10oz)  
**C688** 34.0cl (12oz)



**Soup Cup Handled Stacking**  
**C311** 28.5cl (10oz)



**Soup Cup Unhandled Stacking**  
**C312** 28.5cl (10oz)



**Sugar Packet Container**  
**C389** 10.5cm x 7.0cm x 5.0cm (4<sup>1</sup>/<sub>8</sub>" x 2<sup>3</sup>/<sub>4</sub>" x 2")



**C680** Vogue Sugar Stick Holder



**C071** Mustard Base/Dipper Pot Base  
**C072** Lid for Mustard/Dipper Pot



**C673** Vogue Sugar Pot Covered Complete  
**C674** Vogue Lid for Covered Sugar



**Sugar/Bouillon Cup**  
**C335** 22.75cl (8oz)



**Vogue Teapot**  
**C660** 85.25cl (30oz)  
**C665** Lid 1  
**C661** 42.5cl (15oz)  
**C666** Lid 2  
**C679** 34.0cl (12oz)  
**C666** Lid 2



**Vogue Coffee Pot**  
**C663** 60.0cl (21oz)  
**C667** Lid 3  
**C664** 31.0cl (11oz)  
**C668** Lid 4



**Vogue Jug**  
**C669** 28.5cl (10oz)  
**C670** 14.25cl (5oz)  
**C678** Unhandled 8.0cl (2<sup>1</sup>/<sub>2</sub>oz)



**Vogue Sauce Boat**  
**C672** 34.0cl (12oz)  
**Vogue Mint Boat**  
**C671** 14.25cl (5oz)



**Cream Tot**  
**C099** 2.85cl (1oz)  
**Egg Cup Footless**  
**C040** 4.75cm (1<sup>7</sup>/<sub>8</sub>")



**Tray Stacking**  
**C044** 10.25cm (4")  
**C046** 7.5cm (3")



**C675** Vogue Salt  
**C676** Vogue Pepper  
**C677** Vogue Bud Vase



**C244** Spoon



STEELITE DISTINCTION

**AXIS™**

**flared fresh fine**

Axis bowls add height and drama to the tabletop. Designed to be multi-functional, Axis bowls make many food types look great, providing an architectural presentation style to the dish with minimal effort. Axis offers exciting possibilities, with the opportunity of presenting an entire meal in a collection of various sizes of this bowl.



**Axis Bowl**

- C487** 20.0cm (8") 108.0cl (38oz)
- C488** 15.0cm (6") 45.5cl (16oz)
- C489** 9.7cm (3<sup>7</sup>/<sub>8</sub>") 11.5cl (4oz)



STEELITE DISTINCTION

**FLOAT™**

**literally suspends belief**

With its stunning contemporary shape, Float appears to hover just above the tabletop. An award-winning design, which draws the eye to the food nestling within it's centre.



- C600** 30.5cm (12")  
Large Well 19.0cm (7<sup>1</sup>/<sub>2</sub>")  
54.75cl (19.3oz)



- C602** 30.5cm (12")  
Small Well 12.0cm (5")  
25.75cl (9.1oz)



- C601** 30.5cm (12")  
Medium Well 15.5cm (6")  
32.75cl (11<sup>1</sup>/<sub>2</sub>oz)



GLASS

- 6506G244** 28.0cm (10<sup>5</sup>/<sub>8</sub>")  
Small Well 12.0cm (5")



### smooth, modern lines provide a dramatic tabletop statement

Offering a modern departure from the traditional table setting, Sheer takes geometric design to new levels. Cool and contemporary in style, Quadro looks equally stunning with its softly rounded corners and curved edges. An ideal complement to the modern ranges of Sheer and Quadro, Neo offers a smooth, refreshing take on traditional shape and design. Likewise, Contour offers a truly individual presentation, with seamless lines and a modern twist on round tableware.

STEELITE DISTINCTION

**SHEER™**



**Sheer Bowl**  
**C626** 25.5cm (10") 118.0cl (41½oz)  
**C620** 21.5cm (8½") 67.25cl (23.7oz)  
**C621** 17.75cm (7") 39.75cl (14oz)  
**C625** 14.5cm (5½") 20.0cl (7oz)  
**C622** 10.25cm (4") 5.7cl (2oz)



**Sheer Coupe**  
**C623** 30.0cm (11¾")



**Cone Cup**  
**C639** 34.0cl (12oz)  
**C638** 22.75cl (8oz)  
**C637** 8.5cl (3oz)



**Sheer Saucer**  
**C636** 15.25cm (6")  
 Fits C639,38  
**C635** 11.75cm (4½")  
 Fits C637



**C619** Sheer Salt  
**C618** Sheer Pepper  
**C617** Sheer Bud Vase

STEELITE DISTINCTION

**QUADRO™**

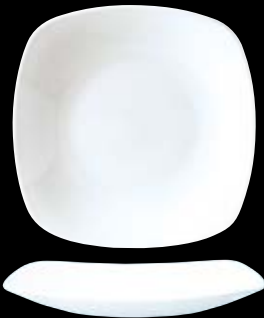

**Quadro Plate**  
**C082** 28.0cm x 28.0cm (11" x 11")



**Quadro Plate**  
**C084** 23.0cm x 23.0cm (9" x 9")



**Quadro Plate**  
**C083** 18.0cm x 18.0cm (7" x 7")



**Quadro Plate**  
**C078** 14.0cm x 14.0cm (5½" x 5½")

STEELITE DISTINCTION

**NEO™**

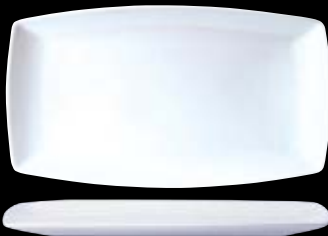

**Neo Eight**  
**C087** 35.5cm x 20.25cm (14" x 8")



**Neo Six**  
**C086** 35.5cm x 15.25cm (14" x 6")



**Neo Four**  
**C085** 35.5cm x 10.0cm (14" x 4")

STEELITE DISTINCTION

**CONTOUR™**

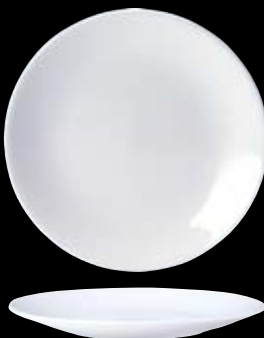

**Contour Plate**  
**C090** 30.0cm (11¾")  
**C1141** 28.0cm (11")  
**C091** 25.5cm (10")  
**C1140** 23.0cm (9")  
**C092** 20.25cm (8")  
**C093** 15.25cm (6")

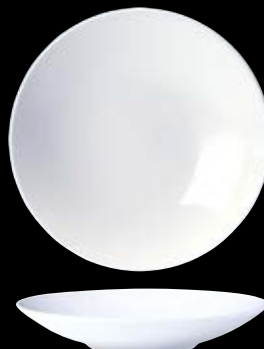

**Contour Bowl**  
**C094** 30.0cm (11¾")  
 177.75cl (62.6oz)  
**C1142** 28.0cm (11")  
 142.25cl (50.1oz)  
**C095** 25.5cm (10")  
 101.5cl (35.7oz)  
**C096** 20.25cm (8")  
 61.75cl (21.7oz)  
**C097** 15.25cm (6")  
 25.75cl (9.1oz)

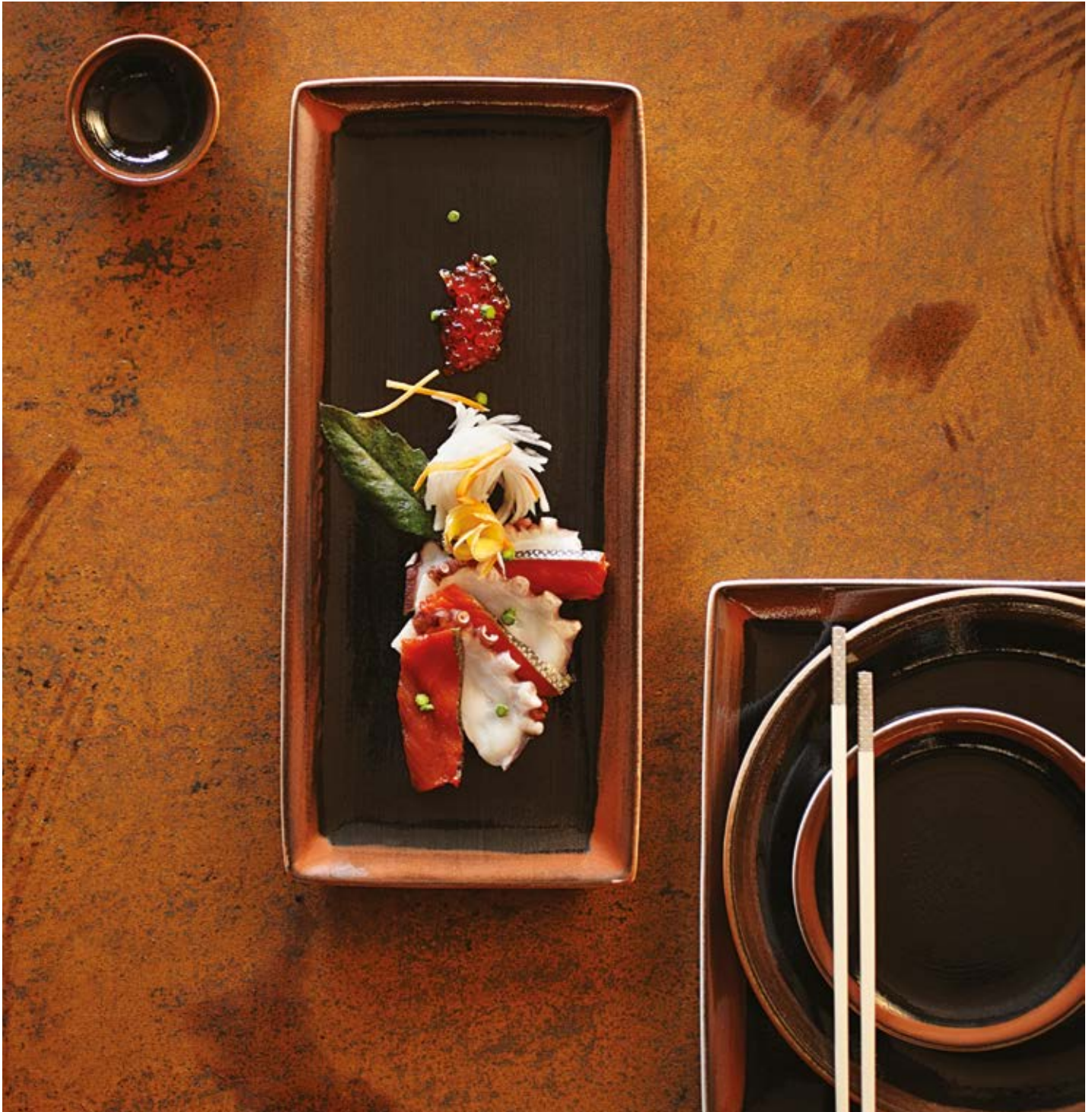

### a daring pattern for a dramatic presentation

Koto, one of Steelite International's most unique ranges, was designed in collaboration with world renowned chef, David Kinch. The inspiration was drawn from ancient Japanese Tenmoku Glazes. These beautiful glazes vary subtly in texture and tone from piece to piece, embodying the craft of the traditional potter. The pieces are hand finished with a rich iron red glaze, which interacts in the kiln to produce a warm, organic, lustrous effect. The deep black textured surface allows food to be perfectly framed, adding drama and contrast to your presentation.



David Kinch



**Rectangle One**  
0550 27.0cm x 16.75cm  
(10<sup>5</sup>/<sub>8</sub>" x 6<sup>1</sup>/<sub>2</sub>" )



**Rectangle Two**  
0551 33.0cm x 27.0cm  
(13" x 10<sup>5</sup>/<sub>8</sub>" )



**Rectangle Three**  
0556 33.0cm x 19.0cm  
(13" x 7<sup>1</sup>/<sub>2</sub>" )



**Rectangle Four**  
0552 37.0cm x 16.5cm  
(14<sup>1</sup>/<sub>2</sub>" x 6<sup>1</sup>/<sub>2</sub>" )



**Square One**  
0553 27.0cm x 27.0cm  
(10<sup>5</sup>/<sub>8</sub>" x 10<sup>5</sup>/<sub>8</sub>" )



**Coupe Plate**  
0565 30.0cm (11<sup>3</sup>/<sub>4</sub>" )  
0566 25.25cm (10" )  
0567 20.25cm (8" )  
0568 15.25cm (6" )



**Coupe Bowl**  
0569 25.25cm (10" )  
120.25cl (42.3oz)  
0570 20.5cm (8<sup>1</sup>/<sub>2</sub>" )  
79.0cl (27.8oz)  
0571 13.0cm (5" )  
16.0cl (5.6oz)



**Bowl**  
C247 15.9cm (6<sup>1</sup>/<sub>4</sub>" )  
80.25cl (28oz)  
C242 12.7cm (5" )  
45.75cl (16oz)  
C248 11.2cm (4<sup>1</sup>/<sub>2</sub>" )  
25.5cl (9oz)  
C249 10.3cm (4" )  
20.0cl (7oz)

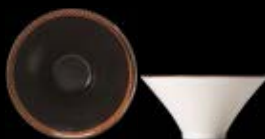

**Axis Bowl**  
C487 20.0cm (8" ) 108.0cl (38oz)  
C488 15.0cm (6" ) 45.75cl (16oz)  
C489 9.7cm (3<sup>7</sup>/<sub>8</sub>" ) 11.5cl (4oz)



**Dish Small**  
C246 7.0cm (3" ) 3.5cl (1<sup>1</sup>/<sub>2</sub>oz)



**Bowl**  
C240 9.4cm (3<sup>3</sup>/<sub>4</sub>" ) 12.75cl (4<sup>1</sup>/<sub>2</sub>oz)



**Cup Unhandled**  
C355 8.5cl (3oz)

Due to the unique hand crafted and hand decorated design of this range each item will vary in texture and finish from the images shown. Each piece will be unique.

PATTERN CODE: 9109



### artistic accented aesthetic

Sumptuous shaped pieces decorated with a delicate floral design. Antoinette's gold decoration looks stunning in a banqueting environment.



**Plate Vogue**  
**C356** 32.0cm (12½")  
**C357** 30.0cm (11¾")  
**C358** 27.0cm (10⅝")  
**C359** 25.5cm (10")  
**C360** 23.0cm (9")  
**C361** 20.25cm (8")  
**C362** 16.5cm (6½")



**Presentation Plate**  
**C347** 30.5cm (12")



**Oval Plate Vogue**  
**C392** 33.0cm (13")  
**C393** 28.0cm (11")  
**C394** 20.25cm (8")



**Pasta Dish**  
**C350** 30.0cm (11¾")  
 56.75cl (20oz)



**Crescent Salad**  
**C063** 20.25cm (8")



**Ultimate Bowl**  
**C344** 30.0cm (11¾")  
 159.0cl (56oz)



**Nouveau Bowl**  
**C365** 30.0cm (11¾")  
 52.5cl (18½oz) well  
**C372** 27.0cm (10⅝")  
 35.75cl (12.6oz) well



**Soup/Pasta**  
**C363** 24.0cm (9½")  
 42.0cl (14.8oz)



**Bowl**  
**C326** 16.5cm (6½")  
 45.5cl (16oz)



**Rim Fruit**  
**C330** 16.5cm (6½")  
 24.5cl (8.6oz)  
**C329** 13.5cm (5¼")  
 13.0cl (4.6oz)



**Soup Cup Handled Stacking**  
**C311** 28.5cl (10oz)



**Soup Cup Unhandled Stacking**  
**C312** 28.5cl (10oz)



**C673** Vogue Sugar Pot Covered Complete  
**C674** Vogue Lid for Covered Sugar



**Sugar/Bouillon Cup**  
**C335** 22.75cl (8oz)



**Packet Sugar**  
**C389** 10.5 x 7.0 x 5.0cm  
 (4⅛" x 2¾" x 2")



**Saucer**  
**C318** 15.25cm (6")  
**C317** 11.75cm (4⅝")



**Cup Stacking**  
**C331** 21.25cl (7½oz)  
**C332** 17.0cl (6oz)  
**C333** 8.5cl (3oz)



**Low Cup**  
**C152** 34.0cl (12oz)  
**C189** 22.75cl (8oz)  
**C190** 8.5cl (3oz)



**Tall Cup**  
**C338** 22.75cl (8oz)  
**C355** Unhandled  
 8.5cl (3oz)



**Mug**  
**C334** 23.75cl (8½oz)



**Vogue Teapot**  
**C660** 85.25cl (30oz)  
**C665** Lid 1  
**C661** 42.5cl (15oz)  
**C666** Lid 2



**Vogue Coffee Pot**  
**C663** 60.0cl (21oz)  
**C667** Lid 3  
**C664** 31.0cl (11oz)  
**C668** Lid 4



**Vogue Jug**  
**C669** 28.5cl (10oz)  
**C670** 14.25cl (5oz)  
**C678** Unhandled  
 8.0cl (2½oz)



**Vogue Sauce Boat**  
**C672** 34.0cl (12oz)



**Vogue Mint Boat**  
**C671** 14.25cl (5oz)



**C675** Vogue Salt  
**C676** Vogue Pepper



**C071** Mustard/Dipper Pot Base  
**C072** Lid



**Egg Cup Footless**  
**C040** 4.75cm (1⅞")



**Tray Stacking**  
**C044** 10.25cm (4")  
**C046** 7.5cm (3")



**C677** Vogue Bud Vase



### contemporary captivating creative

Spyro is a truly spectacular range that combines contemporary forms and traditional finishing. Each piece is individually styled with a delicate swirling embossment that catches the light to create a captivating optical effect of highlights and shadows. Spyro is perfectly at home in any environment, from banqueting to fine dining.



**Plate**  
**C979** 32.0cm (12½")  
**C980** 30.0cm (11¾")  
**C981** 28.0cm (11")  
**C978** 25.5cm (10")  
**C982** 23.0cm (9")  
**C983** 20.25cm (8")  
**C984** 16.5cm (6½")



**Oval Plate**  
**C996** 33.0cm (13")  
**C997** 28.0cm (11")  
**C998** 20.25cm (8")



**Nouveau Bowl**  
**C977** 30.0cm (11¾")  
 49.75cl (17.5oz) well  
**C976** 27.0cm (10⅝")  
 37.0cl (13oz)



**Soup/Pasta**  
**C989** 24.0cm (9½")  
 40.0cl (14.1oz)



**Rectangular Plate**  
**C975** 15.25cm (6")



**Quadro Plate**  
**C743** 28.0cm x 28.0cm  
 (11" x 11")



**Bowl**  
**C744** 20.7cm (8")  
 61.75cl (21.75oz)



**Bowl**  
**C745** 15.0cm (6")  
 32.5cl (11.4oz)



**Bowl**  
**C746** 10.4cm (4")  
 13.0cl (4.6oz)



**Rim Fruit**  
**C737** 16.5cm (6½")  
 25.25cl (8.9oz)  
**C738** 13.5cm (5¼")  
 12.75cl (4½oz)



**Bowl**  
**C736** 16.5cm (6½")  
 50.0cl (17.6oz)



**Soup Cup Handled**  
**C735** 28.5cl (10oz)



**Soup Cup Unhandled**  
**C990** 28.5cl (10oz)



**Cup Stacking**  
**C986** 21.25cl (7½oz)  
**C993** 8.5cl (3oz)



**Low Cup**  
**C994** 34.0cl (12oz)  
**C987** 22.75cl (8oz)  
**C999** 17.0cl (6oz)  
**C995** 8.5cl (3oz)



**Mug**  
**C721** 34.0cl (12oz)



**Saucer**  
**C985** 15.25cm (6")  
**C991** 11.75cm (4⅝")



**Teapot**  
**C724** with Medium Lid  
 60.0cl (21oz)  
**C725** Medium Lid  
**C726** with Small Lid  
 34.0cl (12oz)  
**C727** Small Lid



**Coffee Pot**  
**C728** with Medium Lid  
 60.0cl (21oz)  
**C729** Medium Lid  
**C730** with Small Lid  
 34.0cl (12oz)  
**C731** Small Lid



**Jug**  
**C732** 28.5cl (10oz)  
**C733** 14.25cl (5oz)  
**C734** Unhandled  
 8.0cl (2½oz)



**Sauce Boat**  
**C967** 34.0cl (12oz)



**Sugar/Bouillon Cup**  
**C988** 22.75cl (8oz)



**C740** Salt Pot  
**C741** Pepper Pot



**C742** Bud Vase



Christopher Perera Executive Chef • InterContinental Toronto Yorkville Toronto, Ontario



### inspired by nature

Inspired by nature's forms and shapes, the Organics range is simply stunning. Its fluid lines and flowing curves are uniquely beautiful, whilst its purity and crisp white sophistication will grace the most elegant tabletop. The range is complemented by a glass plate.



Plate  
C645 30.5cm (12")



Plate  
C646 25.5cm (10")



Plate  
C647 20.25cm (8")



Plate  
C658 15.25cm (6")



GLASS

Glass Plate Clear  
6527B710 36.0cm (14")



Bowl  
C642 28.0cm (11")



Bowl  
C643 23.0cm (9")



Bowl  
C644 17.8cm (7")



Tall Bowl  
C648 17.8cm (7")  
C659 15.25cm (6")  
C649 12.7cm (5")



Platter  
C640 51.5cm (20 1/4")



Platter  
C641 37.0cm (14 1/2")



### delicately delivered curves

Outstanding food presentation is assured with the Alvo range. Flowing curves and subtle embossment blend beautifully with the delicate whiteness providing a perfect canvas for any food masterpiece.



**Plate**  
**C500** 30.0cm (11¾")  
**C501** 27.0cm (10⅝")  
**C503** 23.0cm (9")  
**C504** 20.25cm (8")  
**C505** 16.5cm (6½")



**Ultimate Bowl\***  
**C344** 30.0cm (11¾")  
 159.0cl (56oz)



**Crescent Salad\***  
**C063** 20.25cm (8")



**Soup/Pasta**  
**C510** 24.0cm (9½")



**Bowl**  
**C526** 16.5cm (6½")



**Rim Fruit**  
**C530** 16.5cm (6½")  
**C529** 13.5cm (5¼")



**Soup Cup Unhandled Stacking**  
**C512** 28.5cl (10oz)



**Soup Cup Handled Stacking**  
**C511** 28.5cl (10oz)



**Cup Stacking**  
**C531** 21.25cl (7½oz)



**Low Cup**  
**C514** 22.75cl (8oz)



**Saucer**  
**C518** 15.25cm (6")



**C536** **Sugar Bowl Covered Complete**  
 22.75cl (8oz)  
**C568** **Lid for Covered Sugar**  
**C535** **Sugar Bouillon Cup**  
 22.75cl (8oz)



**Teapot**  
**C553** 60.0cl (21oz)  
**C570** Medium Lid  
**C554** 34.0cl (12oz)  
**C571** Small Lid



**Jug**  
**C562** 28.5cl (10oz)  
**C563** 14.25cl (5oz)



**Packet Sugar\***  
**C389** 10.5 x 7.0 x 5.0cm  
 (4⅞" x 2¾" x 2")



**Tray Stacking\***  
**C044** 10.25cm (4")  
**C046** 7.5cm (3")



**Egg Cup Footless\***  
**C040** 4.75cm (1⅞")



**C071** Mustard Base\*  
**C072** Lid for Mustard\*



**Ash Tray Stacking\***  
**C045** 10.25cm (4")

\*Carries no embossment.



### **art deco inspiration**

The Art Deco inspired design of the Bianco range will appeal to the most discerning customer. Ultra-refined, this range was designed to create maximum impact for food presentation.



**Plate**  
**C400** 30.5cm (12")  
**C401** 27.0cm (10<sup>5</sup>/<sub>8</sub>")  
**C402** 25.5cm (10")  
**C403** 23.0cm (9")  
**C404** 20.25cm (8")  
**C405** 15.75cm (6<sup>1</sup>/<sub>4</sub>")



**Presentation Plate\***  
**C347** 30.5cm (12")



**Crescent Salad\***  
**C063** 20.25cm (8")



**Ultimate Bowl\***  
**C344** 30.0cm (11<sup>3</sup>/<sub>4</sub>")  
 159.0cl (56oz)



**Soup Plate**  
**C410** 22.25cm (8<sup>3</sup>/<sub>4</sub>")



**Bowl**  
**C426** 16.5cm (6<sup>1</sup>/<sub>2</sub>")



**Rim Fruit**  
**C430** 16.5cm (6<sup>1</sup>/<sub>2</sub>")  
**C429** 13.5cm (5<sup>1</sup>/<sub>4</sub>")



**Soup Cup Unhandled Stacking**  
**C412** 28.5cl (10oz)



**Soup Cup Handled Stacking**  
**C411** 28.5cl (10oz)



**Cup Tall**  
**C438** 22.75cl (8oz)



**Cup Stacking**  
**C431** 21.25cl (7<sup>1</sup>/<sub>2</sub>oz)



**Tall Cup Unhandled\***  
**C355** 8.5cl (3oz)



**Mug\***  
**C334** 23.75cl (8<sup>1</sup>/<sub>2</sub>oz)



**Saucer**  
**C418** 15.25cm (6")



**Jug**  
**C462** 28.5cl (10oz)  
**C463** 14.25cl (5oz)



**Teapot**  
**C453** 60.0cl (21oz)  
**C459** Lid B



**C436** Sugar Bowl Covered Complete  
**C437** Lid for Covered Sugar Packet Sugar\*



**Sugar/Bouillon Cup**  
**C435** 22.75cl (8oz)



**Tray Stacking\***  
**C044** 10.25cm (4")  
**C046** 7.5cm (3")



**Ash Tray\***  
**C045** 10.25cm (4")



**Egg Cup Footless\***  
**C040** 4.75cm (1<sup>7</sup>/<sub>8</sub>")



**C071** Mustard Base\*  
**C072** Lid for Mustard\*



**C465** Salt  
**C466** Pepper

\*Carries no embossment.



# PERFORMANCE

## Strength and value never looked better

The range of tableware within the Performance collection has been developed to meet the most demanding standards of practicality and presentation. Offering an unrivalled combination of exceptional durability and aesthetic appeal, Performance will showcase your food to perfection, creating an impactful first impression.

## Performance has it all

- high alumina vitrified clay body for long lasting performance
- stunning design with outstanding durability
- exceptional resistance to mechanical and thermal shock
- an extensive selection of shapes, patterns and colours complemented by a stylish selection of oven-to-tableware
- freezer, microwave and dishwasher safe
- Lifetime Edge Chip Warranty

We want you to be as confident in our product as we are, which is why we continue to stand by our worldwide Lifetime Edge Chip Warranty. Applicable to all items manufactured as part of our Performance range, the warranty covers each item for life.

## Steelite International

bringing both strength and design to a whole new level





### the original craft

With two striking new colours – Licorice and Porcini, Craft tableware creates a memorable experience for diners. The new Licorice adds drama and sophistication to the entire range and is in sync with the current trend for black tableware. Visually appealing, Porcini works well with the existing Craft colours, amplifying the rustic effect and reinvigorating an already iconic and market-trusted range. The range embodies the beauty of rich, lustrous glazes applied by hand, and celebrates chance effects and reactions which occur in the kiln.

#### Patterns Available





**Coupe Plate** **NEW**  
 0565 30.0cm (11¾")  
 0566 25.25cm (10")  
 0567 20.25cm (8")  
 0568 15.25cm (6")



**Plate** **NEW**  
 0521 25.0cm (10")



**Rectangle One** **NEW**  
 0550 27.0cm x 16.75cm  
 (10<sup>5</sup>/<sub>8</sub>" x 6<sup>1</sup>/<sub>2</sub>")



**Coupe Bowl** **NEW**  
 0569 25.25cm (10")  
 120.25cl (42.3oz)  
 0570 21.6cm (8½")  
 79.0cl (27.8oz)



**Bowl** **NEW**  
 0524 18.0cm (7")  
 39.5cl (13.9oz)  
 0525 13.0cm (5")  
 12.0cl (4.2oz)



**Low Cup** **NEW**  
 0189 22.75cl (8oz)  
 0190 8.5cl (3oz)



**Stand/Saucer** **NEW**  
**Double Well Large**  
 0158 14.5cm (5¾")  
**Saucer Double Well Small**  
 0165 11.75cm (4<sup>5</sup>/<sub>8</sub>")



**Quench Mug** **NEW**  
 0592 28.5cl (10oz)



**Taster Dip** **NEW**  
 0575 6.5cm x 6.5cm  
 (2½" x 2½")  
 5.75cl (2oz)



**Coupe Plate** **NEW**  
 0565 30.0cm (11¾")  
 0566 25.25cm (10")  
 0567 20.25cm (8")  
 0568 15.25cm (6")



**Plate** **NEW**  
 0521 25.0cm (10")



**Rectangle One** **NEW**  
 0550 27.0cm x 16.75cm  
 (10<sup>5</sup>/<sub>8</sub>" x 6<sup>1</sup>/<sub>2</sub>")



**Coupe Bowl** **NEW**  
 0569 25.25cm (10")  
 120.25cl (42.3oz)  
 0570 21.6cm (8½")  
 79.0cl (27.8oz)



**Bowl** **NEW**  
 0524 18.0cm (7")  
 39.5cl (13.9oz)  
 0525 13.0cm (5")  
 12.0cl (4.2oz)



**Low Cup** **NEW**  
 0189 22.75cl (8oz)  
 0190 8.5cl (3oz)



**Stand/Saucer** **NEW**  
**Double Well Large**  
 0158 14.5cm (5¾")  
**Saucer Double Well Small**  
 0165 11.75cm (4<sup>5</sup>/<sub>8</sub>")



**Quench Mug** **NEW**  
 0592 28.5cl (10oz)



**Taster Dip** **NEW**  
 0575 6.5cm x 6.5cm  
 (2½" x 2½")  
 5.75cl (2oz)

Due to the unique hand crafted and hand decorated design of this range each item will be slightly different in colour and texture from images shown.

PATTERN CODE: 1209

PATTERN CODE: 1129



**natural inspired warmth**

Craft is inspired by hand-crafted, simple country wares made by generations of potters over hundreds of years. The range embodies the beauty of rich, lustrous glazes applied by hand, and celebrates chance effects and reactions which occur naturally in the kiln. The gem-like glazes married to simple forms and shapes produce a unique and individual appearance, giving Craft a rustic "joie de vivre."

Patterns Available



**Coupe Plate**

0565 30.0cm (11 $\frac{3}{4}$ "")  
 0544 28.0cm (11")  
 0566 25.25cm (10")  
 0543 23.0cm (9")  
 0567 20.25cm (8")  
 0568 15.25cm (6")

**Plate**

0501 37.5cm (14 $\frac{5}{8}$ "")

**Plate**

0520 30.5cm (12")

**Rectangle One**

0550 27.0cm x 16.75cm  
 (10 $\frac{5}{8}$ " x 6 $\frac{1}{2}$ "")

**Rectangle Two**

0551 33.0cm x 27.0cm  
 (13" x 10 $\frac{3}{8}$ "")

**Rectangle Three**

0556 33.0cm x 19.0cm  
 (13" x 7 $\frac{1}{2}$ "")

**Rectangle Four**

0552 37.0cm x 16.5cm  
 (14 $\frac{1}{2}$ " x 6 $\frac{1}{2}$ "")

**Square One**

0553 27.0cm x 27.0cm  
 (10 $\frac{5}{8}$ " x 10 $\frac{5}{8}$ "")

**Plate**

0521 25.0cm (10")

**Plate**

0522 15.5cm (6")

**Pizza Plate**

0614 31.5cm (12 $\frac{1}{2}$ "")

**Nouveau**

0372 27.0cm (10 $\frac{3}{4}$ "")  
 34.5cl (12.1oz) well

**Coupe Bowl**

0545 29.0cm (11 $\frac{1}{2}$ "") 183.25cl (64 $\frac{1}{2}$ oz)  
 0569 25.25cm (10") 120.25cl (42.3oz)  
 0570 21.6cm (8 $\frac{1}{2}$ "") 79.0cl (27.8oz)  
 0571 13.0cm (5") 16.0cl (5.6oz)

**Bowl**

0523 28.0cm (11")  
 87.25cl (30.7oz)

**Bowl**

0524 18.0cm (7") 39.5cl (13.9oz)  
 0525 13.0cm (5") 12.0cl (4.2oz)

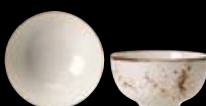
**Chinese Bowl**

0242 13.0cm (5")  
 52.5cl (18 $\frac{1}{2}$ oz)

**Cup Stacking**

0188 28.4cl (10oz)  
 0217 20.0cl (7oz)  
 0234 10.0cl (3 $\frac{1}{2}$ oz)

**Low Cup**

0150 45.5cl (16oz)  
 0152 34.0cl (12oz)  
 0189 22.75cl (8oz)  
 0190 8.5cl (3oz)

**Soup Stand**

**Double Well Slimline**  
 0225 16.5cm (6 $\frac{1}{2}$ "")  
**Stand/Saucer**  
**Double Well Large**  
 0158 14.5cm (5 $\frac{3}{4}$ "")  
**Saucer Double Well Small**  
 0165 11.75cm (4 $\frac{5}{8}$ "")

**Quench Mug**

0591 34.0cl (12oz)  
 0592 28.5cl (10oz)

**Club Teapot**

0367 42.5cl (15oz)  
 0494 Club Lid 2

**Club Jug**

0387 14.25cl (5oz)

**Pourer**

0557 8.5cl (3oz)

**Decanter**

0283 0.6 litre (1 pint)

**Sugar/Bouillon**

0379 22.75cl (8oz)

**Taster Dip**

0575 6.5cm x 6.5cm  
 (2 $\frac{1}{2}$ " x 2 $\frac{1}{2}$ "")  
 5.75cl (2oz)

**0841 Salt**

0842 Pepper

**Casserole Base**

8828 42.5cl (15oz)

**Lid for Casserole**

0829 8828

Due to the unique hand crafted and hand decorated design of this range each item will be slightly different in colour and texture from images shown.

PATTERN CODE: 1155



**Coupe Plate**  
**0565** 30.0cm (11¾")  
**0544** 28.0cm (11")  
**0566** 25.25cm (10")  
**0543** 23.0cm (9")  
**0567** 20.25cm (8")  
**0568** 15.25cm (6")



**Plate**  
**0501** 37.5cm (14⅝")



**Plate**  
**0520** 30.5cm (12")  
**0521** 25.0cm (10")  
**0522** 15.5cm (6")



**Nouveau**  
**0372** 27.0cm (10¾")  
 34.5cl (12.1oz) well



**Coupe Bowl**  
**0545** 29.0cm (11½")  
 183.25cl (64½oz)  
**0569** 25.25cm (10")  
 120.25cl (42.3oz)  
**0570** 21.6cm (8½")  
 79.0cl (27.8oz)  
**0571** 13.0cm (5")  
 16.0cl (5.6oz)



**Rectangle One**  
**0550** 27.0cm x 16.75cm  
 (10⅝" x 6½")

**Rectangle Two**  
**0551** 33.0cm x 27.0cm  
 (13" x 10⅝")

**Rectangle Three**  
**0556** 33.0cm x 19.0cm  
 (13" x 7½")

**Rectangle Four**  
**0552** 37.0cm x 16.5cm  
 (14½" x 6½")

**Square One**  
**0553** 27.0cm x 27.0cm  
 (10⅝" x 10⅝")



**Bowl**  
**0523** 28.0cm (11")  
 87.25cl (30.7oz)



**Bowl**  
**0524** 18.0cm (7")  
 39.5cl (13.9oz)  
**0525** 13.0cm (5")  
 12.0cl (4.2oz)



**Chinese Bowl**  
**0242** 13.0cm (5")  
 52.5cl (18½oz)



**Soup Stand  
 Double Well Slimline**  
**0225** 16.5cm (6½")

**Stand/Saucer  
 Double Well Large**  
**0158** 14.5cm (5¾")

**Saucer Double Well Small**  
**0165** 11.75cm (4⅝")



**Low Cup**  
**0150** 45.5cl (16oz)  
**0152** 34.0cl (12oz)  
**0189** 22.75cl (8oz)  
**0190** 8.5cl (3oz)



**Quench Mug**  
**0591** 34.0cl (12oz)  
**0592** 28.5cl (10oz)



**Club Teapot**  
**0367** 42.5cl (15oz)  
**0494** Club Lid 2



**Club Jug**  
**0387** 14.25cl (5oz)



**Sugar/Bouillon**  
**0379** 22.75cl (8oz)



**Pourer**  
**0557** 8.5cl (3oz)



**Taster Dip**  
**0575** 6.5cm x 6.5cm  
 (2½" x 2½") 5.75cl (2oz)



**Coupe Plate**  
**0565** 30.0cm (11¾")  
**0544** 28.0cm (11")  
**0566** 25.25cm (10")  
**0543** 23.0cm (9")  
**0567** 20.25cm (8")  
**0568** 15.25cm (6")



**Plate**  
**0501** 37.5cm (14⅝")



**Plate**  
**0520** 30.5cm (12")  
**0521** 25.0cm (10")  
**0522** 15.5cm (6")



**Nouveau**  
**0372** 27.0cm (10¾")  
 34.5cl (12.1oz) well



**Coupe Bowl**  
**0545** 29.0cm (11½")  
 183.25cl (64½oz)  
**0569** 25.25cm (10")  
 120.25cl (42.3oz)  
**0570** 21.6cm (8½")  
 79.0cl (27.8oz)  
**0571** 13.0cm (5")  
 16.0cl (5.6oz)



**Rectangle One**  
**0550** 27.0cm x 16.75cm  
 (10⅝" x 6½")

**Rectangle Two**  
**0551** 33.0cm x 27.0cm  
 (13" x 10⅝")

**Rectangle Three**  
**0556** 33.0cm x 19.0cm  
 (13" x 7½")

**Rectangle Four**  
**0552** 37.0cm x 16.5cm  
 (14½" x 6½")

**Square One**  
**0553** 27.0cm x 27.0cm  
 (10⅝" x 10⅝")



**Bowl**  
**0523** 28.0cm (11")  
 87.25cl (30.7oz)



**Bowl**  
**0524** 18.0cm (7")  
 39.5cl (13.9oz)  
**0525** 13.0cm (5")  
 12.0cl (4.2oz)



**Chinese Bowl**  
**0242** 13.0cm (5")  
 52.5cl (18½oz)



**Soup Stand  
 Double Well Slimline**  
**0225** 16.5cm (6½")

**Stand/Saucer  
 Double Well Large**  
**0158** 14.5cm (5¾")

**Saucer Double Well Small**  
**0165** 11.75cm (4⅝")



**Low Cup**  
**0150** 45.5cl (16oz)  
**0152** 34.0cl (12oz)  
**0189** 22.75cl (8oz)  
**0190** 8.5cl (3oz)



**Quench Mug**  
**0591** 34.0cl (12oz)  
**0592** 28.5cl (10oz)



**Club Teapot**  
**0367** 42.5cl (15oz)  
**0494** Club Lid 2



**Club Jug**  
**0387** 14.25cl (5oz)



**Sugar/Bouillon**  
**0379** 22.75cl (8oz)



**Pourer**  
**0557** 8.5cl (3oz)



**Taster Dip**  
**0575** 6.5cm x 6.5cm  
 (2½" x 2½") 5.75cl (2oz)



**Casserole Base**  
**8828** 42.5cl (15oz)  
**Lid for Casserole**  
**0829** 8828



**Coupe Plate**  
**0565** 30.0cm (11¾")  
**0566** 25.25cm (10")  
**0567** 20.25cm (8")  
**0568** 15.25cm (6")



**Plate**  
**0521** 25.0cm (10")



**Rectangle One**  
**0550** 27.0cm x 16.75cm  
 (10<sup>5</sup>/<sub>8</sub>" x 6<sup>1</sup>/<sub>2</sub>")



**Coupe Bowl**  
**0569** 25.25cm (10")  
 120.25cl (42.3oz)  
**0570** 21.6cm (8½")  
 79.0cl (27.8oz)



**Bowl**  
**0524** 18.0cm (7")  
 39.5cl (13.9oz)  
**0525** 13.0cm (5")  
 12.0cl (4.2oz)



**Taster Dip**  
**0575** 6.5cm x 6.5cm  
 (2½" x 2½")  
 5.75cl (2oz)



**Low Cup**  
**0189** 22.75cl (8oz)  
**0190** 8.5cl (3oz)



**Stand/Saucer**  
**Double Well Large**  
**0158** 14.5cm (5¾")  
**Saucer Double Well Small**  
**0165** 11.75cm (4<sup>5</sup>/<sub>8</sub>")



**Quench Mug**  
**0592** 28.5cl (10oz)



**Casserole**  
**0337** 3 litre 5¼pt. (104oz)  
**0338** Casserole Lid



**Coupe Plate**  
**0565** 30.0cm (11¾")  
**0566** 25.25cm (10")  
**0567** 20.25cm (8")  
**0568** 15.25cm (6")



**Plate**  
**0521** 25.0cm (10")



**Rectangle One**  
**0550** 27.0cm x 16.75cm  
 (10<sup>5</sup>/<sub>8</sub>" x 6<sup>1</sup>/<sub>2</sub>")



**Coupe Bowl**  
**0569** 25.25cm (10")  
 120.25cl (42.3oz)  
**0570** 21.6cm (8½")  
 79.0cl (27.8oz)



**Bowl**  
**0524** 18.0cm (7")  
 39.5cl (13.9oz)  
**0525** 13.0cm (5")  
 12.0cl (4.2oz)



**Taster Dip**  
**0575** 6.5cm x 6.5cm  
 (2½" x 2½")  
 5.75cl (2oz)



**Low Cup**  
**0189** 22.75cl (8oz)  
**0190** 8.5cl (3oz)



**Stand/Saucer**  
**Double Well Large**  
**0158** 14.5cm (5¾")  
**Saucer Double Well Small**  
**0165** 11.75cm (4<sup>5</sup>/<sub>8</sub>")



**Quench Mug**  
**0592** 28.5cl (10oz)



**Coupe Plate**  
**0565** 30.0cm (11¾")  
**0566** 25.25cm (10")  
**0567** 20.25cm (8")  
**0568** 15.25cm (6")



**Plate**  
**0521** 25.0cm (10")



**Rectangle One**  
**0550** 27.0cm x 16.75cm  
 (10<sup>5</sup>/<sub>8</sub>" x 6<sup>1</sup>/<sub>2</sub>")



**Coupe Bowl**  
**0569** 25.25cm (10")  
 120.25cl (42.3oz)  
**0570** 21.6cm (8½")  
 79.0cl (27.8oz)



**Bowl**  
**0524** 18.0cm (7")  
 39.5cl (13.9oz)  
**0525** 13.0cm (5")  
 12.0cl (4.2oz)



**Taster Dip**  
**0575** 6.5cm x 6.5cm  
 (2½" x 2½")  
 5.75cl (2oz)



**Low Cup**  
**0189** 22.75cl (8oz)  
**0190** 8.5cl (3oz)



**Stand/Saucer**  
**Double Well Large**  
**0158** 14.5cm (5¾")  
**Saucer Double Well Small**  
**0165** 11.75cm (4<sup>5</sup>/<sub>8</sub>")



**Quench Mug**  
**0592** 28.5cl (10oz)

Due to the unique hand crafted and hand decorated design of this range each item will be slightly different in colour and texture from images shown.

PATTERN CODE: 1132

PATTERN CODE: 1133

PATTERN CODE: 1154



### simmer stew serve

The Craft cookware range offers a variety of presentation opportunities to demonstrate the delights of oven to table cooking. This collection offers a range of items inspired by hand-crafted, simple country wares.



**Oval Eared Dish**

**11310321** 34.0cm x 19.0cm

(13½" x 7½")

103.0cl (36½oz)

**11320320** 30.5cm x 17.0cm

(12" x 6½")

78.0cl (27½oz)

**11330319** 24.5cm x 13.5cm

(9½" x 5½")

36.0cl (12½oz)

**11300318** 20.0cm x 11.0cm

(8" x 4½") 18.5cl (6½oz)



**Round Eared Dish**

**11310317** 21.5cm (8½")

78.0cl (27½oz)

**11300316** 19.0cm (7½")

54.0cl (19oz)

**11330191** 16.5cm (5¾")

18.5cl (6½oz)



**Oval Sole Dish**

**11330326** 28.0cm x 19.0cm

(11⅛" x 7½")

148.0cl (52oz)

**11320327** 21.5cm x 14.0cm

(8½" x 5½")

55.0cl (19oz)



**Oval Baker Lipped**

**11320328** 15.75cm (6¼")

37.0cl (13oz)

**Oval Baker**

**11300400** 15.75cm (6¼")

37.0cl (13oz)



**Rectangular Tray**

**11320366** 16.5cm x 12.3cm

(6½" x 4¾")

50.0cl (17½oz)



**Oblong Roaster**

**11310331** 35.5cm x 30.5cm

(14" x 12") 356cl (125oz)

**11330342** 30.5cm x 25.5cm

(12" x 10") 227.0cl (80oz)



**Square Roaster**

**11300329** 25.5cm (10")

185.0cl (65oz)



**Presentation Pan**

**11310866** 25.5cm (10")

96.0cl (33½oz)



**Casserole Base**

**1155B828** 42.5cl (15oz)

**Lid for Casserole**

**11550829** B828



**Casserole Base**

**1131B828** 42.5cl (15oz)

**Lid for Casserole**

**11310829** B828



**Casserole**

**11320337** 3 litre 5¼apt. (104oz)

**11320338** Casserole Lid

Items are only available in the colours listed.

PATTERN CODE: 1130

PATTERN CODE: 1131

PATTERN CODE: 1132

PATTERN CODE: 1133

PATTERN CODE: 1155



### natural inspired warmth

Taking inspiration from the Craft collection in our Performance body, we've created a tableware offering in melamine that will work perfectly in any casual or buffet setting. Alongside the plates and bowls are four sizes of platter that look stunning on any counterserve or buffet display.



**Plate Coupe** NEW  
 68A540EL043 25.4cm (10")  
 68A540EL788 21.0cm (8 1/4")  
 68A540EL318 16.2cm (6 3/8")



**Oval Coupe Plate** NEW  
 68A540EL571 32.4cm x 22.2cm  
 (12 3/4" x 8 3/4")



**Pasta/Soup Bowl** NEW  
 68A540EL603 22.8cm (9")  
 36.0cl (12.17oz)



**Bowl** NEW  
 68A540EL574 21.3cm (8 3/8")  
 120.0cl (40 1/2oz)  
 68A540EL041 18.1cm (7 1/8")  
 70.0cl (23 3/4oz)  
 68A540EL040 14.3cm (5 5/8")  
 41.0cl (13 3/4oz)



**Square** NEW  
 68A540EL790 22.8cm (9")  
 68A540EL787 17.8cm (7")  
 68A540EL791 12.7cm (5")



**Ramekin** NEW  
 68A540EL786 9.5cm (3 3/4")  
 12.0cl (4oz)



**Rectangle Platter 1/1**  
 68A416EL591 530mm x 325mm  
 (21" x 12 3/4")



**Rectangle Platter 1/2**  
 68A416EL593 325mm x 265mm  
 (12 3/4" x 10 1/2")



**Rectangle Platter 1/3**  
 68A416EL595 325mm x 176mm  
 (12 3/4" x 7")



**Rectangle Platter 2/4**  
 68A416EL597 530mm x 162mm  
 (21" x 6 3/8")



STEELITE PERFORMANCE  
**SCAPE™** NEW ADDITIONS



- S** - Select your material
- C** - Create your plate setting
- A** - Admire your style
- P** - Plate your food
- E** - Enjoy the experience

**natural subtle textures**

A unique tableware collection that offers a multi material approach for dining. With the ability to transition through dining styles from laid back casual to fine formal and through into breakfast buffets and outdoor dining, Scape allows operators to deliver a truly innovative dining experience. With subtle textures and a natural colour palette, Scape works well in any dining environment.

Patterns Available





Coupe Plate **NEW**  
X0065 28.5cm (11<sup>1</sup>/<sub>4</sub>"



Coupe Plate **NEW**  
X0068 20.25cm (8"



Coupe Bowl **NEW**  
X0078 25.0cm (10")  
101.5cl (35.7oz)



Plate  
X0060 37.5cm (14<sup>5</sup>/<sub>8</sub>"



Plate  
X0061 30.5cm (12"



Plate  
X0062 25.0cm (10"



Plate  
X0063 15.5cm (6"



Bowl  
X0070 28.0cm (11")  
87.25cl (30<sup>3</sup>/<sub>4</sub>oz)



Bowl  
X0072 24.0cm (9<sup>1</sup>/<sub>2</sub>")  
36.75cl (13oz)



Bowl  
X0071 25.0cm (10")  
74.0cl (26oz)



Bowl  
X0073 18.0cm (7")  
42.5cl (15oz)



Bowl **NEW**  
X0075 15.5cm (6")  
25.5cl (9oz)



Bowl  
X0074 13.0cm (5")  
11.25cl (4oz)



Mug  
X0080 34.0cl (12oz)



**creations**  
BY STEELITE

CREATIONS  
**SCAPE GLASS™**



Round Platter  
G380 30.0cm (12")



Round Platter  
G379 25.0cm (10")



Round Platter  
G378 14.0cm (5½")



Oval Platter  
G381 40.0cm (16")



Oval Platter  
G382 30.0cm (12")

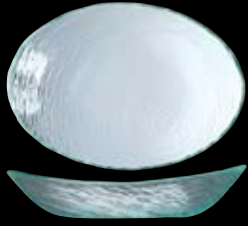

Oval Bowl  
G377 30.0cm (12")



Oval Bowl  
G376 20.0cm (8")



Oval Bowl  
G375 12.5cm (5")

CLEAR: 6512

SMOKED: 6513



**creations**  
BY STEELITE

CREATIONS  
**SCAPE MELAMINE™**



**Plate**  
EL707 28.0cm Dia (11")



**Plate**  
EL706 23.0cm Dia (9")



**Plate**  
EL705 16.5cm Dia (6½")



**Large Oval Platter**  
EL703 40.0cm x 24.2cm  
(16" x 9½")



**Large Oval Bowl**  
EL702  
40.0 x 24.0 x 10.0cm H  
(16" x 9½" x 4")



**Deep Salad Bowl**  
EL700  
30.0cm x 14.0cm H  
(12" x 5½")



**Large Deep Bowl**  
EL701  
25.0cm x 11.0cm H  
(10" x 4¼")



**Medium Deep Bowl**  
EL704  
18.0cm x 7.8cm H  
(7" x 3")



**Small Deep Bowl**  
EL708  
13.0cm x 5.3cm H  
(5" x 2")

WHITE: 68A451

PAPYRUS: 68A452

MUSHROOM: 68A453



## beautifully fractured linear patterns

Crackle patterns have a long and distinguished history going back millennia. Crackling occurs when the glaze does not fit the clay body of the ware correctly, causing it to fracture into beautiful linear patterns, covering the entire surface of the glazed piece. Available in two colourways, Black and Grey, Crackle will add texture and nuance to casual and contemporary food presentations and is aesthetically compatible with both plain white and many of our craft inspired ranges.

Patterns Available



CRACKLE  
BLACK



CRACKLE  
GREY

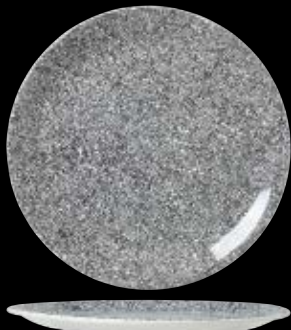

Coupe Plate **NEW**  
0565 30.0cm (11¾")



Coupe Plate **NEW**  
0566 25.25cm (10")

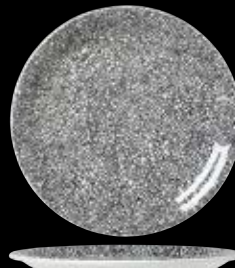

Coupe Plate **NEW**  
0567 20.25cm (8")



Coupe Plate **NEW**  
0568 15.25cm (6")



Coupe Bowl **NEW**  
0569 25.25cm (10")  
120.25cl (42.3oz)



Coupe Bowl **NEW**  
0570 21.6cm (8½")  
79.0cl (27.8oz)



MIX & MATCH WITH

- Craft Liquorice
- Charcoal Dapple
- Taste



**strong confident statement**

Charcoal Dapple adds a new dynamic within this established and successful family. This black reactive decoration creates a strong and confident statement, giving chef a fantastic platform, in which the food presentation is amplified. Charcoal Dapple is perfectly positioned to work with all other decorated and white tableware ranges which provides flexibility to bring through seasonal and menu changes. Careful consideration has been given to ensure all plating options are covered complimented with a beverage offer.



**MIX & MATCH WITH**

- Craft Liquorice
- Ink
- Shikku Glass
- Trattoria Cutlery



Mix and match with Shikku Glass



**Oval Plate Coupe** NEW  
 0145 34.25cm (13½")  
 0142 30.5cm (12")  
 0141 28.0cm (11")  
 0139 20.25cm (8")



**Coupe Plate** NEW  
 0565 30.0cm (11¾")  
 0544 28.0cm (11")  
 0566 25.25cm (10")  
 0543 23.0cm (9")  
 0567 20.25cm (8")  
 0568 15.25cm (6")



**Pizza Plate** NEW  
 0614 31.5cm (12½")



**Coupe Bowl** NEW  
 0545 29.0cm (11½")  
 183.25cl (64½oz)  
 0569 25.25cm (10")  
 120.25cl (42.3oz)  
 0570 21.6cm (8½")  
 79.0cl (27.8oz)  
 0571 13.0cm (5")  
 16.0cl (5.6oz)



**Essence Bowl** NEW  
 0596 20.25cm (8")  
 99.75cl (35.1oz)  
 0597 16.5cm (6½")  
 58.5cl (20.6oz)  
 0598 14.0cm (5½")  
 33.25cl (11.7oz)



**Rectangle One** NEW  
 0550 27.0cm x 16.75cm  
 (10⅝" x 6½")

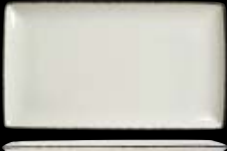

**Rectangle Three** NEW  
 0556 33.0cm x 19.0cm  
 (13" x 7½")



**Square One** NEW  
 0553 27.0cm x 27.0cm  
 (10⅝" x 10⅝")



**Sugar/Bouillon Cup Club** NEW  
 0379 22.75cl (8oz)



**Cup** NEW  
 X0019 35.0cl (12oz)  
 X0020 28.5cl (10oz)  
 X0021 22.75cl (8oz)  
 X0022 17.0cl (6oz)  
 X0023 8.5cl (3oz)



**Quench Mug** NEW  
 0592 28.5cl (10oz)



**Saucer** NEW  
 X0042 15.0cm (6")  
 Fits  
 X0022,21,20,19,18 Cup



**Beverage Pot** NEW  
 X0027 35.0cl (12oz)



**Jug** NEW  
 X0030 14.25cl (5oz)  
**Jug - Unhandled**  
 X0031 8.5cl (3oz)

**Saucer**  
 X0043 12.5cm (5")  
 Fits  
 X0023 3oz Cup



**warm retro appeal**

Rustic & minimal at the same time Brown Dapple blends effortlessly with the Craft and Terramesa offers allowing new and refreshed presentations to emerge. Cool coupes and stacking bowls help deliver elevated styles of food.

Whilst appearances may remind us of a bygone time the items and function of the pieces are extremely practical for todays busy kitchens and fast pace service.



**MIX & MATCH WITH**

- Craft Colours
- Anfora Alma
- Terramesa
- Robert Gordon Pier



**Oval Plate Coupe** **NEW**  
 0145 34.25cm (13½")  
 0142 30.5cm (12")  
 0141 28.0cm (11")  
 0139 20.25cm (8")



**Coupe Plate**  
 0565 30.0cm (11¾")  
 0544 28.0cm (11")  
 0566 25.25cm (10")  
 0543 23.0cm (9")  
 0567 20.25cm (8")  
 0568 15.25cm (6")



**Plate Slimline**  
 0209 27.0cm (10⅝")  
 0210 25.5cm (10")  
 0211 23.0cm (9")  
 0212 20.25cm (8")  
 0214 15.75cm (6¼")



**Pizza Plate**  
 0614 31.5cm (12½")



**Combi-Tray**  
 0360 27.9cm (10")



**Combi-Cup**  
 0182 45.5cl (16oz)



**Coupe Bowl**  
 0545 29.0cm (11½")  
 183.25cl (64½oz)  
 0569 25.25cm (10")  
 120.25cl (42.3oz)  
 0570 21.6cm (8½")  
 79.0cl (27.8oz)  
 0571 13.0cm (5")  
 16.0cl (5.6oz)



**Essence Bowl**  
 0596 20.25cm (8")  
 99.75cl (35.1oz)  
 0597 16.5cm (6½")  
 58.5cl (20.6oz)  
 0598 14.0cm (5½")  
 33.25cl (11.7oz)  
 0595 11.2cm (4½")  
 17.5cl (6.2oz)



**Stackable Bowl**  
 X0008 14.0cm (5½")  
 71.0cl (25oz)



**Stackable Bowl**  
 X0009 11.5cm (4½")  
 42.6cl (15oz)



**Stackable Bowl**  
 X0010 9.0cm (3½")  
 22.7cl (8oz)



**Rectangle One**  
 0550 27.0cm x 16.75cm  
 (10⅝" x 6½")



**Rectangle Three**  
 0556 33.0cm x 19.0cm  
 (13" x 7½")



**Rectangle Six**  
 0618 20.0cm x 10.0cm  
 (8" x 4")



**Square One**  
 0553 27.0cm x 27.0cm  
 (10⅝" x 10⅝")



**Cup**  
 X0019 35.0cl (12oz)  
 X0020 28.5cl (10oz)  
 X0021 22.75cl (8oz)  
 X0022 17.0cl (6oz)  
 X0023 8.5cl (3oz)



**Cup Stacking Slimline**  
 0217 20.0cl (7oz)



**Quench Mug**  
 0592 28.5cl (10oz)



**Saucer Single Well Slimline**  
 0218 15.25cm (6")



**Saucer**  
 X0042 15.0cm (6")  
 Fits  
 X0022, 21, 20, 19, 18 Cup  
 X0010 9.0cm (8oz)  
 Stackable Bowl



**Jug**  
 X0029 28.5cl (10oz)  
 X0030 14.25cl (5oz)



**Covered Sugar**  
 X0032 20.0cl (7oz)



**Beverage Pot**  
 X0027 35.0cl (12oz)



**Round Eared Dish**  
 0317 21.5cm (8½")  
 78.0cl (27½oz)  
 0316 19.0cm (7½")  
 54.0cl (19oz)  
 0191 16.5cm (5¾")  
 18.5cl (6½oz)



**Jug - Unhandled**  
 X0031 8.5cl (3oz)



**Sugar/Bouillon Cup Club**  
 0379 22.75cl (8oz)



**Soup Bowl**  
 0828 42.5cl (15oz)  
 Covered Complete  
 0829 Cover for Soup Bowl  
 B828 Soup Bowl Base  
 Only 42.5cl (15oz)



**warm retro appeal**

They say all good things come back around eventually and that’s certainly the case with this enamel look tableware. A household classic with the added benefit of Steelite International’s lifetime edge chip warranty to provide an up to the minute on trend product.



MIX & MATCH WITH

- Anfora Puebla
- Wabi Sabi Indigo
- Ceres Glass
- Drinique Elite Blue
- Seafood Stands



**Oval Plate Coupe** NEW  
**0145** 34.25cm (13½")  
**0142** 30.5cm (12")  
**0141** 28.0cm (11")  
**0139** 20.25cm (8")



**Coupe Plate**  
**0565** 30.0cm (11¾")  
**0544** 28.0cm (11")  
**0566** 25.25cm (10")  
**0543** 23.0cm (9")  
**0567** 20.25cm (8")  
**0568** 15.25cm (6")



**Plate Slimline**  
**0209** 27.0cm (10<sup>5</sup>/<sub>8</sub>")  
**0210** 25.5cm (10")  
**0211** 23.0cm (9")  
**0212** 20.25cm (8")  
**0214** 15.75cm (6¼")



**Pizza Plate**  
**0614** 31.5cm (12½")



**Combi-Tray**  
**0360** 27.9cm (10")



**Combi-Cup**  
**0182** 45.5cl (16oz)



**Coupe Bowl**  
**0545** 29.0cm (11½")  
 183.25cl (64½oz)  
**0569** 25.25cm (10")  
 120.25cl (42.3oz)  
**0570** 21.6cm (8½")  
 79.0cl (27.8oz)  
**0571** 13.0cm (5")  
 16.0cl (5.6oz)



**Essence Bowl**  
**0596** 20.25cm (8")  
 99.75cl (35.1oz)  
**0597** 16.5cm (6½")  
 58.5cl (20.6oz)  
**0598** 14.0cm (5½")  
 33.25cl (11.7oz)  
**0595** 11.2cm (4½")  
 17.5cl (6.2oz)



**Stackable Bowl**  
**X0008** 14.0cm (5½")  
 71.0cl (25oz)



**Stackable Bowl**  
**X0009** 11.5cm (4½")  
 42.6cl (15oz)



**Stackable Bowl**  
**X0010** 9.0cm (3½")  
 22.7cl (8oz)



**Rectangle One**  
**0550** 27.0cm x 16.75cm  
 (10<sup>5</sup>/<sub>8</sub>" x 6½")



**Rectangle Three**  
**0556** 33.0cm x 19.0cm  
 (13" x 7½")



**Rectangle Six**  
**0618** 20.0cm x 10.0cm  
 (8" x 4")



**Square One**  
**0553** 27.0cm x 27.0cm  
 (10<sup>5</sup>/<sub>8</sub>" x 10<sup>5</sup>/<sub>8</sub>")



**Cup**  
**X0019** 35.0cl (12oz)  
**X0020** 28.5cl (10oz)  
**X0021** 22.75cl (8oz)  
**X0022** 17.0cl (6oz)  
**X0023** 8.5cl (3oz)



**Cup Stacking Slimline**  
**0217** 20.0cl (7oz)



**Quench Mug**  
**0592** 28.5cl (10oz)



**Saucer Single Well Slimline**  
**0218** 15.25cm (6")



**Saucer**  
**X0042** 15.0cm (6")  
**Fits**  
**X0022, 21, 20, 19, 18** Cup  
**X0010** 9.0cm (8oz)  
 Stackable Bowl



**Jug**  
**X0029** 28.5cl (10oz)  
**X0030** 14.25cl (5oz)



**Covered Sugar**  
**X0032** 20.0cl (7oz)



**Beverage Pot**  
**X0027** 35.0cl (12oz)



**Round Eared Dish**  
**0317** 21.5cm (8½")  
 78.0cl (27½oz)  
**0316** 19.0cm (7½")  
 54.0cl (19oz)  
**0191** 16.5cm (5½")  
 18.5cl (6½oz)



**Jug - Unhandled**  
**X0031** 8.5cl (3oz)



**Sugar/Bouillon Cup Club**  
**0379** 22.75cl (8oz)



**Soup Bowl**  
**0828** 42.5cl (15oz)  
 Covered Complete  
**0829** Cover for Soup Bowl  
**B828** Soup Bowl Base Only  
 42.5cl (15oz)



### fun fantastic freeform

FreeStyle is a creative and functional range that puts an organic and elegant twist on a modern concept in casual dining. The range is classic, with sculptural, curvy forms with multifunctional items that sit freely on the table for light and casual dining environments.



Plate  
0501 37.5cm (14<sup>5</sup>/<sub>8</sub>" )



Plate  
0520 30.5cm (12")



Plate  
0521 25.0cm (10")



Plate  
0522 15.5cm (6")



Bowl  
0523 28.0cm (11") 87.25cl (30<sup>3</sup>/<sub>4</sub>oz)



Bowl  
0526 24.0cm (9<sup>1</sup>/<sub>2</sub>" ) 36.75cl (13oz)



Bowl  
0518 25.0cm (10") 74.0cl (26oz)



Bowl  
0524 18.0cm (7") 42.5cl (15<sup>1</sup>/<sub>4</sub>oz)



Bowl  
0519 15.5cm (6") 25.5cl (9oz)

NEW



Bowl  
0525 13.0cm (5") 11.25cl (4<sup>1</sup>/<sub>4</sub>oz)



**excite entertain elevate**

Whether the choice is a signature dish or a toasted sandwich, 'Taste' adds style to any casual dining concept. Our Coupe range of plates and bowls are designed to offer and create a relaxed presentation.



- MIX & MATCH WITH
- FreeStyle
  - Simplicity
  - LiV



**Coupe Plate**

- 0565 30.0cm (11¾")
- 0544 28.0cm (11")
- 0566 25.25cm (10")
- 0543 23.0cm (9")
- 0567 20.25cm (8")
- 0568 15.25cm (6")



**Spice Plate**

- 0579 30.5cm (12")
- 0580 25.5cm (10")
- 0581 20.25cm (8")
- 0582 15.25cm (6")



**Zest Platter**

- 0585 30.5cm (12")
- 0586 25.5cm (10")
- 0587 20.25cm (8")



**Coupe Bowl**

- 0545 29.0cm (11½")  
183.25cl (64½oz)
- 0569 25.25cm (10")  
120.25cl (42.3oz)
- 0570 21.6cm (8½")  
79.0cl (27.8oz)
- 0571 13.0cm (5")  
16.0cl (5.6oz)



**Tulip Bowl**

- 0541 17.5cm (6¾")  
106.0cl (37¼oz)
- 0540 14.0cm (5½")  
51.43cl (18oz)
- 0539 10.0cm (4")  
17.62cl (6¼oz)
- 0538 7.0cm (2¾")  
5.68cl (2oz)



**Square Bowl**

- 0601 25.0cm x 25.0cm (10")  
227.25cl (80oz)
- 0602 20.0cm x 20.0cm (8")  
95.75cl (33.7oz)
- 0603 15.5cm x 15.5cm (6")  
41.5cl (14.6oz)
- 0604 10.0cm x 10.0cm (4")  
12.25cl (4.3oz)



**Angle Bowl**

- 0562 20.25cm (8")  
63.0cl (22.2oz)
- 0563 15.25cm (6")  
27.75cl (9.8oz)
- 0564 10.25cm (4")  
6.75cl (2.4oz)



**Essence Bowl**

- 0596 20.25cm (8")  
99.75cl (35.1oz)
- 0597 16.5cm (6½")  
58.5cl (20.6oz)
- 0598 14.0cm (5½")  
33.25cl (11.7oz)
- 0595 11.2cm (4½")  
17.5cl (6.2oz)



**Scoop Bowl**

- 0574 16.5cm (6½")  
26.75cl (9.4oz)
- 0583 11.2cm (4½")  
7.75cl (2.7oz)
- 0584 8.8cm (3½")  
3.5cl (1.2oz)



**Tasters Tray**

- 0577 25.5cm x 13.0cm  
(10" x 5")



**Tasters Bowl**

- 0576 13.0cm x 13.0cm (5" x 5")  
30.5cl (10.75oz)



**Souper Douper**

- 0558 60.0cl (21¼oz)

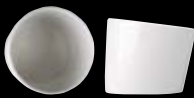

**Tilt Pot Tall**

- 0599 7.5cm x 7.9cm  
(3" x 3½")  
23.5cl (8.3oz)



**Tasters Dip**

- 0575 6.5cm x 6.5cm  
(2½" x 2½")  
5.75cl (2oz)



**Round Stacking Tray**

- 0559 20.25cm (8")
- 0560 16.5cm (6½")
- 0561 13.5cm (5½")
- 0471 7.5cm (3")



**Pourer**

- 0557 8.5cl (3oz)



**Sauce pot**

- 0608 17.0cl (6oz)



STEELITE PERFORMANCE  
TASTE SQUARES & RECTANGLES™



**Square One**  
0553 27.0cm x 27.0cm  
(10<sup>5</sup>/<sub>8</sub>" x 10<sup>5</sup>/<sub>8</sub>" )



**Rectangle One**  
0550 27.0cm x 16.75cm  
(10<sup>5</sup>/<sub>8</sub>" x 6<sup>1</sup>/<sub>2</sub>" )



**Rectangle Two**  
0551 33.0cm x 27.0cm  
(13" x 10<sup>5</sup>/<sub>8</sub>" )



**Rectangle Three**  
0556 33.0cm x 19.0cm  
(13" x 7<sup>1</sup>/<sub>2</sub>" )



**Rectangle Four**  
0552 37.0cm x 16.5cm  
(14<sup>1</sup>/<sub>2</sub>" x 6<sup>1</sup>/<sub>2</sub>" )



**Rectangle Five**  
0549 29.0cm x 14.0cm  
(11<sup>1</sup>/<sub>2</sub>" x 5<sup>1</sup>/<sub>2</sub>" )



**Rectangle Six**  
0618 20.0cm x 10.0cm  
(8" x 4")

**combine then dine**

Whether the choice is a signature dish or a hotdog, 'Taste' adds style to any casual dining concept. Classic squares and rectangles will provide options for Tapas to Tiramisu to add to your collection of high performing product.



**creations**  
BY STEELITE

CREATIONS  
**TASTE GLASS™**



**Rectangle Platter**  
**6506G348** 33.0cm x 18.5cm  
(13" x 7 1/4")



**Rectangle Platter**  
**6506G349** 32.5cm x 26.5cm  
(12 3/4" x 10 3/8")



**Rectangle Platter**  
**6506G350** 26.5cm x 16.0cm  
(10 3/8" x 6 1/4")



**Rectangle Platter**  
**6506G352** 36.8cm x 16.0cm  
(14 1/2" x 6 1/4")



**Square Platter**  
**6506G353** 26.5cm x 26.5cm  
(10 3/8" x 10 3/8")

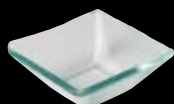

**Square Bowl**  
**6527B830** 12.7cm (5")  
24.0cl (8oz)

**combine then dine**

Taste glassware offers a new dimension in culinary presentation allowing you to mix items with the existing range of Taste squares and rectangles and also bringing a lighter alternative to the presentation whilst delivering complete flexibility to any range.



## clean crisp colour

The Terramesa range is full of colour and rustic style, and as the name suggests, it has been designed to be both natural and earthy. Whether it's Mexican food with its hot and vibrant colours, Spanish tapas or Asian food, Terramesa offers an exceptional range of shapes and sizes to complement the colours and ingredients present in these types of cuisine. With the growing trend for artisan inspired hand crafted ranges Terramesa gives your tabletop that wow factor. Decorated in four complementary shades and hand-finished with a textured reactive glaze on the edge, Terramesa looks stunning when colours are mixed or used independently.

### Patterns Available





**Spice Plate**  
 0579 30.5cm (12")  
 0580 25.5cm (10")  
 0581 20.25cm (8")  
 0582 15.25cm (6")



**Zest Platter**  
 0585 30.5cm (12")  
 0586 25.5cm (10")  
 0587 20.25cm (8")



**Essence Bowl**  
 0596 20.25cm (8")  
 0597 16.5cm (6½")  
 0598 14.0cm (5½")



**Scoop Bowl**  
 0574 16.5cm (6½")  
 0583 11.2cm (4½")  
 0584 8.8cm (3½")



**Tasters Tray**  
 0577 25.5cm x 13.0cm  
 (10" x 5")



**Tasters Bowl**  
 0576 13.0cm x 13.0cm  
 (5" x 5")



**Tilt Pot**  
 0599 7.5cm (h) x 7.9cm (w)  
 (3" x 3½")



**Tasters Dip**  
 0575 6.5cm x 6.5cm  
 (2½" x 2½")



**Quench Mug**  
 0592 28.5cl (10oz)



**Low Cup Empire**  
 0189 22.75cl (8oz)  
 0190 8.5cl (3oz)



**Saucer Double Well Slimline**  
 0225 16.5cm (6½")  
**Saucer Double Well**  
 0158 Large 14.5cm (5¾")  
 0165 Small 11.75cm (4⅝")



**Club Teapot**  
 0367 42.5cl (15oz)  
 0494 Club Lid 2



**Club Jug**  
 0387 14.25cl (5oz)



**Sugar/Bouillon Cup**  
 0379 22.75cl (8oz)



0841 Salt Harmony  
 0842 Pepper Harmony



**Casserole Base**  
 B828 42.5cl (15oz)  
 0829 Casserole Lid



**Tasters Charger (Dark Wood)**  
 6515T346 30.0cm x 30.0cm  
 (11¾" x 11¾")



**Tasters Charger (Light Wood)**  
 6515T345 30.0cm x 30.0cm  
 (11¾" x 11¾")



### quality variety versatility

A simple yet effective plain white pattern made in Steelite International's strong and highly durable ceramic body. The range offers a large choice of options to enhance any food service presentation.



**Plate Slimline**  
**0209** 27.0cm (10<sup>5</sup>/<sub>8</sub>"")  
**0210** 25.5cm (10")  
**0211** 23.0cm (9")  
**0212** 20.25cm (8")  
**0213** 17.75cm (7")  
**0214** 15.75cm (6<sup>1</sup>/<sub>4</sub>"")



**Plate Harmony**  
**0810** 31.5cm (12<sup>1</sup>/<sub>2</sub>"")  
**0811** 30.0cm (11<sup>3</sup>/<sub>4</sub>"")  
**0812** 27.0cm (10<sup>5</sup>/<sub>8</sub>"")  
**0813** 25.5cm (10")  
**0814** 23.0cm (9")  
**0815** 20.25cm (8")  
**0816** 16.5cm (6<sup>1</sup>/<sub>2</sub>"")



**Service/Chop Plate**  
**0343** 33.0cm (13")  
**0226** 30.0cm (11<sup>3</sup>/<sub>4</sub>"")  
**0336** 27.0cm (10<sup>5</sup>/<sub>8</sub>"")



**Pizza Plate**  
**0614** 31.5cm (12<sup>1</sup>/<sub>2</sub>"")  
**0710** 28.0cm (11")



**Crescent Salad**  
**0207** 20.25cm (8")



**Plate Cresta**  
**0700** 25.5cm (10")  
**0703** 20.25cm (8")  
**0705** 16.5cm (6<sup>1</sup>/<sub>2</sub>"")



**Oval Plate Coupe**  
**0146** 39.5cm (15<sup>1</sup>/<sub>2</sub>"")  
**0145** 34.25cm (13<sup>1</sup>/<sub>2</sub>"")  
**0142** 30.5cm (12")  
**0141** 28.0cm (11")  
**0140** 25.5cm (10")  
**0139** 20.25cm (8")



**Combi-Tray**  
**0360** 27.9cm (10")



**Nouveau Bowl**  
**0365** 30.0cm (11<sup>3</sup>/<sub>4</sub>"")  
 57.75cl (20.3oz) well  
**0372** 27.0cm (10<sup>5</sup>/<sub>8</sub>"")  
 34.5cl (12.1oz) well



**Pasta Plate**  
**0350** 30.0cm (11<sup>3</sup>/<sub>4</sub>"")  
 56.75cl (20oz)  
**0314** 27.0cm (10<sup>5</sup>/<sub>8</sub>"")  
 42.0cl (14.8oz)



**Ultimate Bowl**  
**0344** 30.0cm (11<sup>3</sup>/<sub>4</sub>"")  
 159.0cl (56oz)  
**0356** 27.0cm (10<sup>5</sup>/<sub>8</sub>"")  
 118.0cl (41<sup>1</sup>/<sub>2</sub>oz)



**Soup Plate Rimmed Atlanta**  
**0114** 23.0cm (9")  
 44.0cl (15<sup>1</sup>/<sub>2</sub>oz)



**Harmony Soup/Pasta Plate**  
**0363** 24.0cm (9<sup>1</sup>/<sub>2</sub>"")  
 45.75cl (16.1oz) well



**Soup Plate**  
**0215** 21.5cm (8<sup>1</sup>/<sub>2</sub>"")  
 39.75cl (14oz)



**Soup Coupe**  
**0116** 19.0cm (7<sup>1</sup>/<sub>2</sub>"")  
 54.75cl (19.3oz)



**Fruit Stone Rim**  
**0130** 16.5cm (6<sup>1</sup>/<sub>2</sub>"")  
 27.0cl (9.5oz)



**Salad Bowl**  
**0461** 23.0cm (9")  
 116.5cl (41oz)



**Soup Bowl Club**  
**0219** 31.25cl (11oz)  
**Sugar/Bouillon Cup Club**  
**0379** 22.75cl (8oz)



**Chinese Bowl**  
**0242** 12.75cm (5")  
 52.5cl (18<sup>1</sup>/<sub>2</sub>oz)



**Oatmeal Bowl**  
**0126** 16.5cm (6<sup>1</sup>/<sub>2</sub>"")  
 51.5cl (18.1oz)  
**0429** 14.0cm (5<sup>1</sup>/<sub>2</sub>"")  
 31.25cl (11oz)



**Soup Cup Unhandled Stacking**  
**0121** 28.5cl (10oz)



**Soup Cup Lugged Stacking**  
**0115** 28.5cl (10oz)



**Soup Cup Handled Stacking**  
**0119** 28.5cl (10oz)



**Combi-Cup**  
**0182** 45.5cl (16oz)



**Stacking Bowl**  
**0308** 21.0cm (8<sup>1</sup>/<sub>4</sub>"")  
 185.0cl (66oz)  
**0309** 17.0cm (6<sup>2</sup>/<sub>3</sub>"")  
 90.0cl (31<sup>1</sup>/<sub>2</sub>oz)  
**0310** 13.0cm (5")  
 39.0cl (13oz)



**Soup Bowl**  
**0828** 42.5cl (15oz)  
 Covered Complete  
**0829** Cover



**Low Cup Empire**  
 0150 45.5cl (16oz)  
 0152 34.0cl (12oz)  
 0189 22.75cl (8oz)  
 0184 17.0cl (6oz)  
 0190 8.5cl (3oz)



**Cup Tall Slimline**  
 0216 20.0cl (7oz)



**Mug Club**  
 0349 28.5cl (10oz)  
 0346 23.75cl (8½oz)



**Cup Stacking Slimline**  
 0188 28.4cl (10oz)  
 0217 20.0cl (7oz)  
 0230 17.0cl (6oz)  
 0234 10.0cl (3½oz)



**Cup Stacking Atlanta**  
 0154 21.25cl (7½oz)



**Grand Café**  
 0546 28.5cl (10oz)  
 0547 17.0cl (6oz)  
 0548 7.5cl (2½oz)



**Stacking Beaker**  
 0403 26.0cl (9oz)



**Atlantic Mug**  
 0183 34.0cl (12oz)



**Coffeehouse Mug**  
 0464 56.75cl (20oz)  
 0404 45.5cl (16oz)  
 0401 34.0cl (12oz)  
 0465 26.5cl (9½oz)



**Aroma Mug**  
 0527 19.0cl (6½oz)  
 0528 8.5cl (3oz)



**Quench Mug**  
 0590 45.5cl (16oz)  
 0591 34.0cl (12oz)  
 0592 28.5cl (10oz)  
 0593 22.75cl (8oz)  
 0594 8.5cl (3oz)



**Saucer Double Well**  
 0158 14.5cm (5¾")  
 0165 11.75cm (4⅝")



**Saucer/Soup Stand Double Well Slimline**  
 0225 16.5cm (6½")



**Saucer Single Well Slimline**  
 0218 15.25cm (6")



**Butter Pad**  
 0147 10.25cm (4")  
**Butter Block**  
 0332 2.85cl (1oz)



**Teapot**  
**0179** 42.5cl (15oz)  
**0181** Teapot Lid



**Teapot Club**  
**0367** 42.5cl (15oz)  
**0494** Teapot Club Lid 2



**Coffee Pot Harmony**  
**0830** 85.25cl (30oz)  
**0846** Lid Size 2\*  
**0831** 60.0cl (21oz)  
**0847** Lid Size 3\*  
**0832** 31.0cl (11oz)  
**0848** Lid Size 4\*  
 \*White Only



**Teapot Harmony**  
**0833** 85.25cl (30oz)  
**0845** Lid Size 1\*  
**0834** 60.0cl (21oz)  
 Fits 6475LY01 Harmony Teapot Infuser  
**0846** Lid Size 2\*  
**0835** 31.0cl (11oz)  
**0847** Lid Size 3\*  
 \*White Only



**Decanter**  
**0282** 1.1ltr (2pts.)  
**0283** 0.6ltr (1pt.)



**Jug Harmony**  
**0837** 28.5cl (10oz)  
**0838** 14.25cl (5oz)  
**0839** (Unhandled)  
 7.0cl (2½oz)



**Sauce Boat Harmony**  
**0843** 37.0cl (13oz)  
**Mint Boat Harmony**  
**0844** 12.75cl (4½oz)



**Packet Sugar**  
**0389** 10.5 x 7.0 x 5.0cm  
 (4⅞" x 2¾" x 2")



**Harmony Teapot Infuser**  
**6475LY01**



**Oil/Vinegar Jar**  
**0235** 17.0cl (6oz)  
 Complete  
**0237** Stopper Only  
**0498** Mustard Base/  
 Dipper Pot Base  
**0499** Lid for Mustard  
 Base/Dipper Pot Base



**Ashtray Stacking**  
**0479** 10.25cm (4")  
**Tray Stacking**  
**0470** 10.25cm (4")



**Covered Sugar Harmony**  
**0836** 20.0cl (7oz)  
**0849** Lid



**0840** Bud Vase Harmony  
**0841** Salt Harmony  
**0842** Pepper Harmony



**Egg Cup Footless**  
**0206** 4.75cm (1⅜")  
**Cream Tot**  
**0205** 2.85cl (1oz)



### **simmer stew serve**

The cookware range offers a variety of presentation opportunities to demonstrate the delights of oven to table cooking. Bring the intoxicating aromas, sights and sounds of your menu to the guest as you captivate their senses with the Simplicity range of cookware. Create an unforgettable tabletop presentation with Simplicity White.



**Casserole**  
**0337** 3 litre 5¼pt. (104oz)  
**0338** Lid 3 litre  
**0334** 2 litre 3½pt. (75oz)  
**0335** Lid 2 litre



**Soup Bowl**  
**0828** 42.5cl (15oz)  
 Covered Complete  
**0829** Cover  
**B828** Soup Bowl Base Only  
 42.5cl (15oz)



**Presentation Pan**  
**0866** 25.5cm (10")  
 96.0cl (33½oz)



**Round Eared Dish**  
**0317** 21.5cm (8½")  
 78.0cl (27½oz)  
**0316** 19.0cm (7½")  
 54.0cl (19oz)  
**0191** 16.5cm (5½")  
 18.5cl (6½oz)



**Oval Eared Dish**  
**0321** 34.0cm x 19.0cm  
 (13½" x 7½")  
 103.0cl (36½oz)  
**0320** 30.5cm x 17.0cm  
 (12" x 6½")  
 78.0cl (27½oz)  
**0319** 24.5cm x 13.5cm  
 (9½" x 5½")  
 36.0cl (12½oz)  
**0318** 20.0cm x 11.0cm  
 (8" x 4½")  
 18.5cl (6½oz)



**Oblong Roaster**  
**0331** 35.5cm x 30.5cm  
 (14" x 12")  
 356.0cl (125oz)  
**0342** 30.5cm x 25.5cm  
 (12" x 10")  
 227.0cl (80oz)

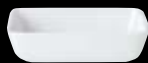

**Rectangular Tray**  
**0366** 16.5cm x 12.3cm  
 (6½" x 4¾")  
 50.0cl (17½oz)



**Square Roaster**  
**0329** 25.5cm (10")  
 185.0cl (65oz)



**Oval Baker**  
**0400** 15.75cm (6¼")  
 37.0cl (13oz)



**Oval Sole Dish**  
**0326** 28.0cm x 19.0cm  
 (11" x 7½")  
 148.0cl (52oz)  
**0327** 21.5cm x 14.0cm  
 (8½" x 5½")  
 55.0cl (19oz)



**Salad Bowl**  
**0461** 23.0cm (9")



**Stacking Bowl**  
**0308** 21.0cm (8¼")  
 185.0cl (66oz)  
**0309** 17.0cm (6⅔")  
 90.0cl (31½oz)  
**0310** 13.0cm (5")  
 39.0cl (13oz)



**Butter Block**  
**0332** 2.85cl (1oz)  
**Ramekin**  
**0324** 8.4cm (3¼")  
 16.0cl (5½oz)  
**0323** 7.4cm (3")  
 11.5cl (4oz)  
**0322** 6.4cm (2½")  
 7.0cl (2½oz)



**Oval Baker (Lipped)**  
**0328** 15.75cm (6¼")  
 37.0cl (13oz)



**Decanter**  
**0282** 1.1ltr (2pts.)  
**0283** 0.6ltr (1pt.)  
**Oil/Vinegar Jar**  
**0235** 17.0cl (6oz)  
**0237** Stopper Only



### edgy fun streetwise

LiV is all about how we live our lives today. City life is fast-paced, time challenged and busy, yet we still crave the “new” and are ever hungry for fresh and invigorating experiences. Continually fresh ideas and innovation promote an ever-changing approach to new combinations of tastes, textures and presentation. LiV is edgy, fun, casual and creative. It encourages a streetwise approach to food presentation, whilst being super-easy to use in space constrained and busy environments.



**Cup**  
**X0018** 45.5cl (16oz)  
**X0019** 35.0cl (12oz)  
**X0020** 28.5cl (10oz)  
**X0021** 22.75cl (8oz)  
**X0022** 17.0cl (6oz)  
**X0023** 8.5cl (3oz)



**Saucer**  
**X0042** 15.0cm (6")  
**Fits**  
**X0022,21,20,19,18** Cup  
**X0010** 9.0cm (8oz)  
 Stackable Bowl  
**Saucer**  
**X0043** 12.5cm (5")  
**Fits**  
**X0023** 3oz Cup



**Beverage Pot**  
**X0025** 60.0cl (21oz)  
**X0026** Lid No 1  
**X0027** 35.0cl (12oz)



**Covered Sugar**  
**X0032** 20.0cl (7oz)  
**X0033** Lid



**Jug**  
**X0029** 28.5cl (10oz)  
**X0030** 14.25cl (5oz)



**Jug - Unhandled**  
**X0031** 8.5cl (3oz)



**Stackable Bowl**  
**X0008** 14.0cm (5½")  
 71.0cl (25oz)



**Stackable Bowl**  
**X0009** 11.5cm (4½")  
 42.6cl (15oz)



**Stackable Bowl**  
**X0010** 9.0cm (3½")  
 22.7cl (8oz)



STEELITE PERFORMANCE  
**RIO™**

**mix and match**

This colourful range brings a fresh look to tableware and is the ideal choice for an informal bistro effect or to add colour to self-service catering environments. The range is available in a choice of four colours which can be used on their own, or combined together for a mix and match presentation.



- Plate Slimline**  
0209 27.0cm (10<sup>5</sup>/<sub>8</sub>"")  
0210 25.5cm (10")  
0211 23.0cm (9")  
0212 20.25cm (8")  
0214 15.75cm (6<sup>1</sup>/<sub>4</sub>"")



- Service/Chop Plate**  
0226 30.0cm (11<sup>3</sup>/<sub>4</sub>"")



- Oatmeal Bowl**  
0126 16.5cm (6<sup>1</sup>/<sub>2</sub>"")  
0429 14.0cm (5<sup>1</sup>/<sub>2</sub>"")



- Soup Plate**  
0215 21.5cm (8<sup>1</sup>/<sub>2</sub>"")



- Fruit Atlanta**  
0131 13.5cm (5<sup>1</sup>/<sub>4</sub>"")



- Soup Cup**  
**Unhandled Stacking**  
0121 28.5cl (10oz)



- Sugar/Bouillon Cup Club**  
0379 22.75cl (8oz)



- Mug Club**  
0349 28.5cl (10oz)



- Low Cup Empire**  
0189 22.75cl (8oz)



- Cup Stacking Slimline**  
0217 20.0cl (7oz)  
0230 17.0cl (6oz)



- Saucer Double Well**  
0158 14.5cm (5<sup>3</sup>/<sub>4</sub>"")  
0165 11.75cm (4<sup>3</sup>/<sub>8</sub>"")  
**Saucer/Soup Stand**  
**Double Well Slimline**  
0225 16.5cm (6<sup>1</sup>/<sub>2</sub>"")



- Saucer Single Well**  
**Slimline**  
0218 15.25cm (6")

Patterns Available





STEELITE PERFORMANCE  
**CARNIVAL™**

**colourful casual dining**

Carnival offers a wide range of products providing a complete tabletop in four vibrant colours. A fun alternative to food presentation with countless possible combinations.



**Plate Slimline**  
0209 27.0cm (10<sup>5</sup>/<sub>8</sub>"")  
0212 20.25cm (8")  
0214 15.75cm (6<sup>1</sup>/<sub>4</sub>"")



**Saucer Double Well Slimline**  
0225 16.5cm (6<sup>1</sup>/<sub>2</sub>"")



**Saucer Double Well Large**  
0158 14.5cm (5<sup>3</sup>/<sub>4</sub>"")  
0165 11.75cm (4<sup>5</sup>/<sub>8</sub>"")



**Low Cup Empire**  
0150 45.5cl (16oz)  
0152 34.0cl (12oz)  
0189 22.75cl (8oz)  
0184 17.0cl (6oz)  
0190 8.5cl (3oz)



**Mug Club**  
0349 28.5cl (10oz)



Patterns Available

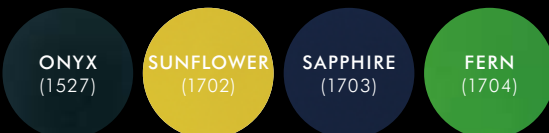



STEELITE PERFORMANCE  
FREEDOM™



**inspiring innovative independent**

Freedom has been developed and designed by Steelite to introduce a radical new product range that responds to the needs of today's patients in healthcare. Freedom Yellow and Blue with a two tone colour contrast is a vibrant warm and homely tableware collection that has been specifically designed to aid functionality and independence in eating and drinking whilst brightening up meal service for individuals with restricted mobility or memory.

The range can be co-ordinated with other standard ranges enabling people with restricted mobility to enjoy meals alongside their friends and family.



STEELITE PERFORMANCE  
**FREEDOM™**

Patterns Available



Plate  
0122 25.5cm (10")



Plate Slimline  
0211 23.0cm (9")



Plate Slimline  
0214 15.75cm (6¼")



Essence Bowl  
0598 14.0cm (5½")



Beaker Stacking  
0403 26.0cl (9oz)



CREATIONS  
**FREEDOM MELAMINE™**

Patterns Available



Freedom Plate  
EL677 25.0cm (10")



Plate  
EL668 23.0cm (9")



Plate  
EL667 16.5cm (6½")



Bowl  
EL669 20.3cm (8")



STEELITE PERFORMANCE  
**FREEDOM™**

Patterns Available



Plate Slimline  
0209 27.0cm (10⅝")  
0210 25.5cm (10")  
0211 23.0cm (9")  
0212 20.25cm (8")  
0213 17.75cm (7")  
0214 15.75cm (6¼")



Plate  
0122 25.5cm (10")



Plate  
0123 21.6cm (8½")



Oatmeal Bowl  
0126 16.5cm (6½")



Soup Plate  
0215 21.5cm (8½")



Saucer Double Well  
0158 14.5cm (5¾")



Beaker Stacking  
0403 26.0cl (9oz)



Double Handled Mug  
0149 28.5cl (10oz)



Cup Stacking Slimline  
0217 20.0cl (7oz)  
0230 17.0cl (6oz)



Jug Harmony  
0838 14.25cl (5oz)



## warm veined presentation

Introducing the highly innovative serving pieces, now offered in an even larger array of styles. Prepared from either acacia wood or olive wood, these pieces are designed to resist the penetration of liquids, stains and odours.

Adopt the unique serving boards as an alternative to traditional plating and add dramatic dimensions to the total presentation.

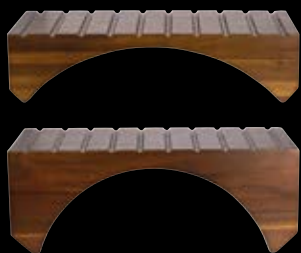

**Set of 2 Arch Bridge Acacia Wood** **NEW**  
**TW309** 40.64 x 15.24 x 10.16cm &  
 40.64 x 15.24 x 15.24cm  
 (16" x 6" x 4" & 16" x 6" x 6")



**6 Level Coffee/Condiment** **NEW**  
**Acacia Wood Stand**  
**TW310** 52.07 x 35.56 x 31.75cm  
 (20½" x 14" x 12½")



**4 Level Signature Stand Acacia Wood** **NEW**  
**TW311** 72.39 x 55.25 x 22.86cm  
 (28½" x 21¾" x 9")



**Rectangular Platform Acacia Wood** **NEW**  
**TW312** 52.71 x 32.7 x 15.24cm  
 (20¾" x 12⅞" x 6")



**Rectangular Platform Acacia Wood** **NEW**  
**TW313** 32.39 x 26.67 x 20.32cm  
 (12¾" x 10½" x 8")



**Square Platform Acacia Wood** **NEW**  
**TW314** 17.78 x 17.78 x 30.48cm  
 (7" x 7" x 12")



**Oval Faceted Acacia Board** **NEW**  
**TW321** 71.1 x 30.5 x 5.0cm (h)  
 (28" x 12" x 2" h)



**Square Faceted Acacia Board** **NEW**  
**TW322** 38.1 x 38.1 x 5.0cm (h)  
 (15" x 15" x 2" h)



**Serving Board Rustic Edge Acacia**  
**TW306** 51.0cm x 20.25cm  
 (20" x 8")  
**TW305** 40.5cm x 16.5cm  
 (16" x 6½")



**Serving Board Paddle Olive**  
**TW302** 44.0cm x 23.0cm (17¼" x 9")  
**TW301** 38.0cm x 19.5cm (15" x 7¾")



**Serving Plate Olive**  
**TW304** 35.0cm x 16.5cm (13¾" x 6½")



**Serving Plate Olive**  
**TW303** 30.0cm x 14.0cm (11¾" x 5½")



### unique flexible recessed

A range of wooden serving pieces, designed to provide the perfect platform for our operators to play with the theatre and presentation to the table. Stage is stylish, versatile and provides an innovative approach to service, enhancing the visual impact, creating space and service solutions to the table.



**Large Oval Platter**  
T353 42.2cm x 29.0cm  
(16½" x 11½")



**Medium Oval Platter**  
T352 36.0cm x 26.0cm  
(14¼" x 10¼")



**Small Oval Platter**  
T351 30.0cm x 23.0cm  
(11¾" x 9")



**Double Sided Platter**  
T347 39.0cm x 30.0cm  
(15¾" x 11¾")



**Double Sided Platter**  
T348 34.0cm x 24.0cm  
(13¾" x 9½")



**Riser Platter**  
T349 37.0cm x 16.8cm  
(14½" x 6¾")



**Riser**  
T350 31.0cm x 16.0cm x 13.0cm  
(12" x 6¾" x 5¼")

PATTERN CODE: 6516



### cool glass carriers

This range includes one size of tray in two contrasting colours; clear and smoked, with a triple well in the centre of each piece allowing compatible Steelite bowls to nestle safely whilst creating theatre for food styling.

Our glass trays have been designed to fit the Stage wooden riser to create height and space in service. They also stand alone and can be used for direct food service presentation.



**Glass Serving Tray - Clear**  
G383 35.0cm (13¾")



**Glass Serving Tray - Smoked**  
G384 35.0cm (13¾")

PATTERN CODE: 6506



Bone China is a soft paste porcelain, very fine and translucent which was first made in England in 1645.

Our range offered under the umbrella of Royal Crown Derby represents a vision to create tableware as a luxury statement for use in fine restaurants and hotels around the world to deliver an exquisite dining experience to be savoured.





# ROYAL CROWN DERBY

## Elegance meets contemporary

Royal Crown Derby is a range of delicate shapes in fine bone china, made in the heart of England. All of the tableware has elegance combined with practical appeal, making it the perfect choice for fine dining. Royal Crown Derby delivers a refreshing high end presentation and provides chefs with a beautiful canvas for their foodservice presentation.

- high end appeal
- modern look & feel
- reactive artisan glazes
- unique textures and finishes
- hand applied decoration

**Royal Crown Derby**  
tactile and sensuous



ROYAL CROWN DERBY  
MADE IN ENGLAND



### premium polished perfection

The Art Glaze range from Royal Crown Derby constitutes an upmarket artisan aesthetic allied to the purity and whiteness of fine bone china. Each piece is unique as reactive glazes obtain their beauty through random and chance effects due to kiln firing, glaze chemistry and their being applied by hand.

The four coloured glazes have been developed to be beautiful individually, or in contrast with each other. Special attention has been given to deliver a refreshing, high-end presentation platform to best showcase chef-driven menus.

#### Patterns Available



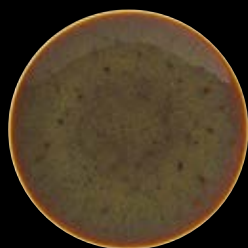

**Coupe Plate**

- BC806 34.0cm (13½")
- BC807 30.0cm (12")
- BC808 27.0cm (10⅝")
- BC809 25.0cm (10")
- BC810 21.0cm (8")
- BC811 16.0cm (6¼")



**Coupe Bowl**

- BC814 30.0cm (12")
- BC821 25.5cm (10") **NEW**
- BC813 22.5cm (8¾")
- BC820 16.5cm (6½")



**Deep Bowl**

- BC812 14.5cm (5¾")



**Bowl**

- BC825 13.5cm (5⅓") **NEW**
- 42.6cl (15oz)



**Bowl**

- BC826 11.5cm (4½") **NEW**
- 31.2cl (11oz)



**Nouveau Bowl**

- BC174 27.0cm (10⅝")



**Sauce Dish**

- BC121 11.0cm (4¼")
- 4.8cl (1⅓/soz)



**Urban Mug**

- BC827 34.0cl (11½oz) **NEW**



**Urban Teacup**

- BC833 35.48cl (12oz) **NEW**
- BC829 23.65cl (8oz)
- BC828 8.87cl (3oz)



**Urban Saucer**

- BC836 16.5cm (6½") **NEW**
- Fits 12oz
- BC835 15.0cm (5⅞")
- Fits 8oz
- BC834 11.6cm (4⅔")
- Fits 3oz

CARAMEL: 8501

SMOKE: 8502

SKY: 8503

MULBERRY: 8504



## striking style statement

The Studio Glaze range from Royal Crown Derby exhibits the very best of casual ware, each piece being subtly different and unique due to its hand-applied decoration. Reactive pigments in combination with coloured glazes create a textured interplay of materials to deliver a silky sheen on the surface of each piece. The effect is tactile and sensuous, showcasing food in a contemporary and unique way. Artisan inspired and relaxed in nature, the Studio Glaze range allows Chefs the perfect canvas for creative food presentation.

### Patterns Available





**Coupe Plate**

- BC806 34.0cm (13½")
- BC807 30.0cm (12")
- BC808 27.0cm (10⅝")
- BC809 25.0cm (10")
- BC810 21.0cm (8")
- BC811 16.0cm (6¼")



**Coupe Bowl**

- BC814 30.0cm (12")
- BC821 25.5cm (10") **NEW**
- BC813 22.5cm (8¾")
- BC820 16.5cm (6½")



**Deep Bowl**

- BC812 14.5cm (5¾")



**Bowl**

- BC825 13.5cm (5⅓") **NEW**
- 42.6cl (15oz)



**Bowl**

- BC826 11.5cm (4½") **NEW**
- 31.2cl (11oz)



**Nouveau Bowl**

- BC174 27.0cm (10⅝")



**Sauce Dish**

- BC121 11.0cm (4¼")
- 4.8cl (1⅓oz)



**Urban Mug**

- BC827 34.0cl (11½oz) **NEW**



**Urban Teacup**

- BC833 35.48cl (12oz) **NEW**
- BC829 23.65cl (8oz)
- BC828 8.87cl (3oz)

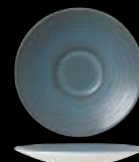

**Urban Saucer**

- BC836 16.5cm (6½") **NEW**
- Fits 12oz
- BC835 15.0cm (5⅞")
- Fits 8oz
- BC834 11.6cm (4⅔")
- Fits 3oz



The Anfora collection of contemporary tableware is designed specifically for casual, fast paced establishments. Offering an unrivalled combination of value, exceptional durability and good looks, the Anfora range of tableware is competitively priced and has the attributes to satisfy all of your requirements.

The results are strength and style perfectly balanced

- excellent performance
- extremely practical and versatile
- fully vitrified clay body
- each range has a full suite of items
- perfect for the casual dining atmosphere



1920  
ANFORAANFORA  
ALMA™

## authentic artisan style

The Anfora collection of contemporary tableware has been designed by Steelite's creative director Andrew Klimecki to bring authentic artisan stoneware into fast-paced food service environments. Offering an unrivalled combination of value, exceptional durability and good looks, the Anfora range of tableware is competitively priced and has the attributes to satisfy all of your casual dining requirements.

This one-of-a-kind design creates a unique food experience. The Alma collection represents unrefined beauty and brings a touch of elegance to any table.

### Patterns Available





**Coupe Plate**  
P096A 27.0cm (10¾")



**Coupe Plate**  
P094A 23.0cm (9")



**Coupe Plate**  
P093A 19.0cm (7½")

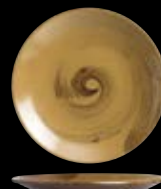

**Coupe Plate**  
P092A 15.5cm (6")



**Oval Platter**  
P128A 34.0cm x 23.0cm  
(13½" x 9")



**Oval Platter**  
P236A 25.5cm x 19.0cm  
(10" x 7½")



**Cafe Bowl**  
P160A 21.5cm x 7.5cm  
(8⅝" x 3")  
142.0cl (50oz)



**Cafe Bowl**  
P161A 19.0cm x 7.0cm  
(7⅝" x 2¾")  
108.0cl (38oz)



**Noodle Bowl**  
P217A 14.0cm x 6.3cm  
(5½" x 2⅝")  
52.5cl (18½oz)



**Coffee Mug**  
P070A 25.5cl (9oz)



**Coupe Plate**  
P096A 27.0cm (10¾")



**Coupe Plate**  
P094A 23.0cm (9")



**Coupe Plate**  
P093A 19.0cm (7½")



**Coupe Plate**  
P092A 15.5cm (6")



**Oval Platter**  
P128A 34.0cm x 23.0cm  
(13½" x 9")

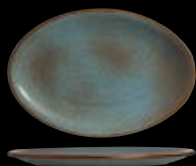

**Oval Platter**  
P236A 25.5cm x 19.0cm  
(10" x 7½")



**Cafe Bowl**  
P160A 21.5cm x 7.5cm  
(8⅝" x 3")  
142.0cl (50oz)



**Cafe Bowl**  
P161A 19.0cm x 7.0cm  
(7⅝" x 2¾")  
108.0cl (38oz)



**Noodle Bowl**  
P217A 14.0cm x 6.3cm  
(5½" x 2⅝")  
52.5cl (18½oz)



**Coffee Mug**  
P070A 25.5cl (9oz)



**Coupe Plate**  
P095A 25.5cm (10")



**Coupe Plate**  
P093A 19.0cm (7½")



**Cucina Pasta**  
P213A 24.0cm x 9.0cm  
(9½" x 3⅝")  
183.0cl (64½oz)



**Baja Bowl**  
P158A 23.4cm x 6.4cm  
(9⅓" x 2½")  
128.0cl (45oz)

1920  
ANFORA ANFORA  
PUEBLA™



### fresh fun vibe

Puebla brings old world charm to both traditional and modern cuisine. The authentic Puebla design is hand painted by skilled artisans, and its unique design offers that extra flare your tabletop desires.

Great to be used as an entire place setting or just accent pieces blended with Steelite core ranges. All 9" plates are accents only in vibrant hand painted colours of Mexican inspiration.



**Chop Plate**  
P105A 33.0cm (13")



**Rimmed Plate**  
P104A 31.0cm (12¼")  
P103A 26.0cm (10¼")  
P102A 23.0cm (9")  
P101A 19.0cm (7½")  
P100A 15.75cm (6¼")



**Oval Platter**  
P145A 34.0cm x 23.5cm  
(13½" x 9¼")  
P142A 31.0cm x 23.0cm  
(12¼" x 9⅛")  
P140A 27.0cm x 19.7cm  
(10⅝" x 7¾")



**Narrow Rim Platter**  
P245A 34.0cm x 27.0cm  
(13½" x 10¾")



**Oval Rarebit**  
P152A 25.5cm x 13.0cm  
(10" x 5")  
34.0cl (12oz)



**Rolled Edge Pasta Bowl**  
P050A 30cm x 5.5cm  
(11¾" x 2⅛")  
74.0cl (26oz)



**Fruit Bowl**  
P029A 11.5cm x 3.2cm  
(4⅝" x 1¼")  
10.0cl (3½oz)



**Molcajete**  
P175A 16.5cm x 10.0cm  
(6½" x 4")  
31.0cl (11oz)



**Astro Bowl**  
P270A 15.0cm x 5.0cm  
(6" x 2")  
48.0cl (17oz)



**Oatmeal Bowl**  
P032A 13.0cm x 6.0cm  
(5" x 2⅜")  
38.0cl (13½oz)



**Nappy Bowl**  
P033A 13.0cm x 5.0cm  
(5¼" x 2")  
34.0cl (12oz)



**Bouillon Cup**  
P079A 10.0cm x 6.0cm  
(4" x 2½")  
26.0cl (9oz)



**Unhandled Cup**  
P132A 20.0cl (7oz)



**Acapulco Mug**  
P049A 12.0cm x 9.0cm  
(4¾" x 3½")  
28.5cl (10oz)



**Rimmed Plate**  
A121P102A 23.0cm (9")



**Rimmed Plate**  
A122P102A 23.0cm (9")



**Rimmed Plate**  
A123P102A 23.0cm (9")



**Rimmed Plate**  
A124P102A 23.0cm (9")



**Rimmed Plate**  
A125P102A 23.0cm (9")



BLUE: A120



CORAL: A121

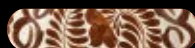

BROWN: A122



SAND DUNE: A123

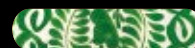

PALM LEAF: A124



BLUE LAGOON: A125



# PORCELAIN

The Porcelain ranges from Robert Gordon, Rene Ozorio, Crucial Detail and Varick are uniquely designed offers, which bring a sensational added dimension to the dining experience. Created to explore everything that dining has to offer, these ranges draw on all the senses to help the diner fully appreciate chefs creations.





# ROBERT GORDON

## Heritage leads to innovation

For over 70 years and three generations, Robert Gordon Australia has been making quality pottery. The brand stands for craftsmanship and creativity, and has been built around the importance of its heritage. While continuing to grow because of its excitement for the future, Robert Gordon pieces are created with a strong focus on innovation and design. Synonymous with quality, these porcelain products are designed and developed in Australia then handed over to China for production, ensuring the Australian aesthetic is not lost.

- Beautiful, naturalist porcelain
- Freezer, oven, microwave and dishwasher safe
- Perfect for casual & family dining
- Unique and exciting collection

**Robert Gordon**  
creative australian aesthetic

**ROBERT  
GORDON**  
**AUSTRALIA**  
POTTERS SINCE 1945



## unique natural extraordinary

The Potters Collection by Robert Gordon includes an exciting and informal assortment of embossed plates, platters, bowls and accessories in two unique colours: Pier and Storm. Each colour has a distinct finish that is stunning on its own or can be beautifully mixed to create an unforgettable tabletop. The reactive glaze on Pier and Storm ensures that no two pieces of this Australian-designed porcelain will be exactly alike, and Pier's neutral taupe and Storm's deep blue colour intensity varies from piece to piece.

### Patterns Available



PIER  
(6121)

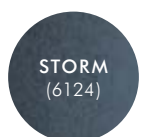

STORM  
(6124)



Plate **NEW**  
RG015 26.7cm (10½")



Plate **NEW**  
RG009 23.2cm (9¼")



Plate **NEW**  
RG017 19.0cm (7½")



Coupe Dish **NEW**  
RG010 18.4cm (7¼")



Coupe Dish **NEW**  
6124RG001A 12.7cm (5")  
6124RG001A 12.7cm (5")



Bowl **NEW**  
RG006 28.9cm (11¾")  
193.0cl (68oz)



Bowl **NEW**  
RG004 22.8cm (9")  
114.0cl (40oz)



Deep Bowl **NEW**  
RG007 20.0cm (7⅞")  
102.0cl (36oz)



Rectangle Tray **NEW**  
RG018 38.0cm x 17.8cm  
(15" x 7")

RG019 25.5cm x 15.25cm  
(10" x 6")



Round Deep Tray **NEW**  
RG003 16.5cm (6½")  
4.25cl (1.5oz)



Handled Deep Tray **NEW**  
RG008 16.8cm x 13.0cm  
(6⅝" x 5⅛")  
29.0cl (10¼oz)



Round Tray **NEW**  
RG002 16.5cm (6½")



Ramekin **NEW**  
6121RG005 8.57cm (3⅜")  
18.0cl (6oz)  
6124RG005A 8.57cm (3⅜")  
18.0cl (6oz)



Condiment Tray **NEW**  
RG012 8.1cm (3⅛")  
7.0cl (2½oz)



Handled Crock **NEW**  
RG014 13.6cm x 10.2cm  
(5⅜" x 4")  
25.6cl (9oz)



Oil Dish **NEW**  
RG011 9.8cm x 8.5cm  
(3⅞" x 3⅜")  
5.7cl (2oz)



Spice Dish **NEW**  
RG013 6.7cm x 6.0cm  
(2⅝" x 2⅜")  
2.85cl (1oz)



Mug **NEW**  
RG016 33.4cl (11¾oz)



# RENE OZORIO

## Tablescapes in chic porcelain

"Tableware should be tactile, functional and possess elements of surprise and delight." This is the philosophy that has led Rene Ozorio to become a world renowned designer of restaurant concepts and tableware for over 15 years.

Designing cutting edge, yet functional shapes in porcelain, bone china and cutlery, Rene Ozorio is not only familiar with, but has been responsible for shaping good service trends. An inspiration in his own right, Rene Ozorio believes the creation of each item should provide the guest with a subliminal poetry of sensation and experience of daily life. Words truly lived up to by the eloquent magnitude of the Rene Ozorio Collection.



Rene Ozorio

## For inspired presentations offering a myriad of opportunities

- cool blue-white porcelain
- unique artisan glazes
- delicate embossments
- captivating shape and form
- functional design
- integrated ranges

**Rene Ozorio**  
designed to delight

**RENE OZORIO**

RENE OZORIO

RENE OZORIO  
WABI SABI™

## the art of imperfection

Introducing the Wabi Sabi collection, the latest design by Rene Ozorio. Combining his simplistic porcelain shapes with reactive ceramic glazes, Rene Ozorio has developed a pattern of unparalleled raw beauty. Embodying an imperfect style and a natural semi matte finish, no two pieces of these double-fired, hand-glazed items are alike.

The Wabi Sabi range provides chefs with the ability to plate on organically inspired pieces. Available in colours Wheat, Slate, Indigo, Lichen and Galet.

### Patterns Available





**Plate Rimmed  
W/Glossy Well**  
MY003 28.5cm (11¼")



**Plate Rimmed**  
MY002 24.0cm (9½")  
MY001 15.25cm (6")



**Bowl Flat Rimmed**  
MY006 27.0cm x 5.75cm  
(10<sup>5</sup>/<sub>8</sub>" x 2¼")



**Bowl Flat Rimmed**  
MY005 24.0cm x 5.0cm  
(9½" x 2")



**Bowl Flat Rimmed**  
MY004 21.0cm (8¼")



**Plate Rimmed  
W/Glossy Well**  
MY003 28.5cm (11¼")



**Plate Rimmed**  
MY002 24.0cm (9½")  
MY001 15.25cm (6")



**Bowl Flat Rimmed**  
MY006 27.0cm x 5.75cm  
(10<sup>5</sup>/<sub>8</sub>" x 2¼")  
MY005 24.0cm x 5.0cm  
(9½" x 2")  
MY004 21.0cm (8¼")



**Tray Round**  
MY020 28.5cm (11¼")



**Tray Round**  
MY021 15.25cm (6")



**Tray Square**  
MY016 28.5cm (11¼")



**Tray Square**  
MY017 16.0cm (6¼")



**Tray Rectangle**  
MY018 28.5cm x 14.0cm  
(11¼" x 5½")



**Tray Rectangle**  
MY019 16.0cm x 7.5cm  
(6¼" x 3")



**Plate Coupe**  
 MY009 28.5cm (11¼")  
 MY007 15.25cm (6")



**Bowl Coupe**  
 MY012 26.0cm x 4.0cm  
 (10¼" x 1½")



**Bowl Coupe Rimmed**  
 MY015 24.0cm x 6.5cm  
 (9<sup>5</sup>/<sub>8</sub>" x 2<sup>5</sup>/<sub>8</sub>" )  
 MY014 20.0cm x 6.0cm  
 (8" x 2<sup>3</sup>/<sub>8</sub>" )  
 MY013 16.5cm (6½")



**Tray Round**  
 MY020 28.5cm (11¼")



**Tray Round**  
 MY021 15.25cm (6")



**Tray Square**  
 MY016 28.5cm (11¼")



**Tray Square**  
 MY017 16.0cm (6¼")



**Tray Rectangle**  
 MY018 28.5cm x 14.0cm  
 (11¼" x 5½")



**Tray Rectangle**  
 MY019 16.0cm x 7.5cm  
 (6¼" x 3")



Plate Coupe  
MY009 28.5cm (11¼")



Plate Coupe  
MY007 15.25cm (6")



Bowl Coupe  
MY012 26.0cm x 4.0cm  
(10¼" x 1⅝")



Bowl Coupe Rimmed  
MY015 24.0cm x 6.5cm  
(9⅝" x 2⅝")



Bowl Coupe Rimmed  
MY014 20.0cm x 6.0cm  
(8" x 2⅜")



Bowl Coupe Rimmed  
MY013 16.5cm (6½")



Plate Coupe  
MY009 28.5cm (11¼")

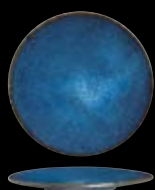

Plate Coupe  
MY007 15.25cm (6")



Bowl Coupe  
MY012 26.0cm x 4.0cm  
(10¼" x 1⅝")



Bowl Coupe Rimmed  
MY015 24.0cm x 6.5cm  
(9⅝" x 2⅝")



Bowl Coupe Rimmed  
MY014 20.0cm x 6.0cm  
(8" x 2⅜")



Bowl Coupe Rimmed  
MY013 16.5cm (6½")

RENE OZORIO

RENE OZORIO  
**SONATA™**

### **soul satisfying sophistication**

Design by Rene Ozorio, the Sonata collection's embossment is a delicate note which complements the strong direction of the shapes. A welcome departure from the formal "nouvelle" and "fusion" cuisine of the past, Sonata's sophisticated embossment of radiant lines centres the visual focus on the well of each plate and bowl, placing emphasis on the cuisine being served.

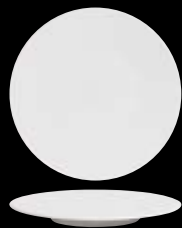

**Coupe Plate**  
P1024 17.0cm (6¾")



**Coupe Deep Plate**  
P1025 30.5cm (12")  
P1026 27.0cm (10<sup>5</sup>/<sub>8</sub>")  
P1027 23.0cm (9")  
P1028 19.0cm (7½")



**Signature Plate**  
P1000 30.0cm (12")  
12.0cm (4¾") Well



**Signature Plate**  
P1001 30.0cm (12")  
16.0cm (6¼") Well



**Signature Plate**  
P1002 30.0cm (12")  
18.0cm (7") Well



**Signature Gourmet Plate**  
P1005 27.0cm (10<sup>5</sup>/<sub>8</sub>")  
13.0cm (5") Well



**Side Plate**  
P1015 17.0cm (6¾")



**Coupe Bowl**  
P1053 26.0cm x 4.5cm  
(10¼" x 1¾")  
96.6cl (34oz)



**Rimmed Cereal Bowl**  
P1029 21.0cm x 7.3cm  
(8¼" x 2<sup>7</sup>/<sub>8</sub>")  
36.0cl (12¾oz)



**Signature Gourmet Bowl**  
P1003 27.0cm (10<sup>5</sup>/<sub>8</sub>")



**Signature Gourmet Bowl**  
P1004 23.5cm (9¼")



**Signature Thimble Bowl**  
P1008 10.0cm (3<sup>7</sup>/<sub>8</sub>")  
9.0cl (3oz)



**Signature Mini Bowl**  
P1009 10.0cm (4")



**Bouillon Cup**  
P1031 34.0cl (12oz)



**Cappuccino Cup**  
P1032 34.0cl (12oz)



**Coffee Cup**  
P1034 23.0cl (9oz)



**Tea Cup**  
P1035 20.0cl (8oz)



**Espresso Cup**  
P1037 10.0cl (3<sup>1</sup>/<sub>2</sub>oz)



**Tea/Coffee Pot w/Lid**  
P1056 54.7cl (18½oz)



**Saucer**  
P1033 18.0cm (7")  
Fits P1031 & P1032



**Saucer**  
P1036 16.5cm (6½")  
Fits P1034 & P1035



**Saucer**  
P1038 13.0cm (5¼")  
Fits P1037



**Sugar Bowl w/Lid**  
P1063 25.5cl (9oz)



**Creamer Handled**  
P1061 17.0cl (6oz)

RENE OZORIO

RENE OZORIO  
AURA™

### chic textured forms

The Rene Ozorio Aura Collection is uniquely designed to bring a sensational added dimension to the dining experience, creating a complete sensory occasion. Discover the new ease of Rene Ozorio with Aura Banquet plates. Sized to fit one plate cover, they are the creative solution to make banqueting easy and efficient. The new plates have all the signature elegance of the original Aura collection, with a banquet friendly delivery.



**Presentation Plate**  
P590 28.5cm (11¼")



**Presentation Plate**  
P592 28.5cm (11¼") 7" Well



**Coupe Plate**  
P593 28.5cm (11¼")



**Medium Rim Plate Large Well**  
P006 30.0cm (11¾")  
Well 14.0cm (5½")  
P307 28.0cm (11¼")  
P302 27.0cm (10¾")  
P303 24.0cm (9½")  
P304 22.0cm (8¾")  
P305 17.0cm (6¾")  
P306 15.0cm (6")



**Broad Rim Medium Well Plate**  
P001 30.0cm (11¾")



**Flat Rim Plate**  
P010 27.0cm (10½")  
P013 17.0cm (6¾")



**Flat Rim Coupe Plate**  
P007 30.0cm (11¾")



**Deep Plate**  
P059 30.0cm (11¾")  
100.0cl (35oz)  
P060 21.0cm (8")  
38.0cl (13oz)



**Pasta Plate**  
P594 28.5cm (11¼")  
5½" Well



**Rimmed Pasta Plate**  
P595 28.5cm (11¼")



**Broad Rim Pasta Plate**  
P008 30.0cm (11¾")  
Well Size 14.0cm (5½")



**Presentation Soup Base**  
P054 30.0cm (11¾")  
35.0cl (12½oz)  
**Lid for Presentation Soup**  
P066 30.0cm (11¾")



**Bowl**  
P055 18.0cm (7⅛")  
30.0cl (10½oz)



**Cereal Bowl**  
P091 14.0cm (5½")  
22.0cl (7¾oz)



**Soup/Pasta**  
P076 24.0cm (9¼")  
65.0cl (23oz)



**Soup Cup Handled**  
P064 30.0cl (10oz)



**Saucer**  
P182 17.75cm (7")  
(fits P185 & P064)  
P183 16.5cm (6½")  
(fits P192)  
P180 16.0cm (6¼")  
(fits P192 & P186)  
P181 12.0cm (4⅝")  
(fits P187)



**Breakfast Cup**  
P185 30.0cl (11oz)



**Mug**  
P191 23.0cl (8oz)



**Tea Cup**  
P192 20.0cl (6¾oz)



**Cup**  
P187 7.0cl (2½oz)



**Stacking Cup**  
P186 23.0cl (8oz)



**Egg Cup/Plate**  
P164 12.0cm (5")



**Coffee Pot**  
P152 36.0cl (11¾oz)  
P157 Lid fits 6300P152



**Teapot**  
P155 65.0cl (20oz)  
P199 Lid fits 6300P155



**Jug**  
P148 25.0cl (8½oz)  
**Jug Unhandled**  
P149 15.0cl (5oz)  
P150 7.0cl (2oz)



**Covered Sugar Base**  
P144 16.2cl (5½oz)  
P145 Lid



**Sugar Bowl**  
P151 10.0cm (4")  
24.0cl (8oz)



P160 Salt  
P161 Pepper



**Tray Square**

- P103 29.0cm (11½")
- P108 26.0cm (10¼")
- P089 22.0cm (8⅝")
- P102 13.0cm (5⅛")



**Tray Rectangular**

- P101 35.0cm x 15.9cm  
(13¾" x 6¼")
- P105 27.0cm x 14.0cm  
(10⅝" x 5½")
- P107 24.0cm x 12.0cm  
(9½" x 4¾")

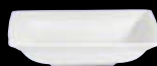

**Square Soup Plate**

- P081 18.0cm (7") 33.0cl (11oz)



**Oval Platter**  
**P309** 36.2cm (14<sup>1</sup>/<sub>8</sub>"")  
**P380** 28.2cm (11")



**Presentation Bowl**  
**P050** 24.5cm (9<sup>3</sup>/<sub>4</sub>"")  
 47.0cl (16oz)  
**P051** 20.5cm (8<sup>1</sup>/<sub>5</sub>"")  
 21.0cl (7oz)



**Deep Coupe Bowl**  
**P071** 26.0cm (11")  
 159.0cl (54oz)



**Bowl**  
**P044** 20.0cm (8")  
 98.0cl (34oz)  
**P045** Lid for 6300P044  
**P043** 17.0cm (6<sup>5</sup>/<sub>8</sub>"")  
 56.0cl (19oz)  
**P042** Lid for 6300P043  
**P040** 14.0cm (5<sup>1</sup>/<sub>2</sub>"")  
 30.0cl (10oz)  
**P041** Lid for 6300P040



**Rice Bowl**  
**P351** 10.5cm (4<sup>1</sup>/<sub>8</sub>"")  
 25.0cl (8<sup>1</sup>/<sub>2</sub>oz)



**Spoon**  
**P358** 13.0cm (5<sup>1</sup>/<sub>8</sub>"")



**Sushi Dish**  
**P251** 31.5cm x 17.5cm  
 (12<sup>1</sup>/<sub>2</sub>" x 6<sup>1</sup>/<sub>4</sub>"")



**Coupe Sauce Dish**  
**P354** 9.0cm (3<sup>1</sup>/<sub>2</sub>"")



**Soya Dish**  
**P256** 7.5cm (3")



**Soy Sauce/Vinegar**  
**P370** Pot w/Lid  
 13.0cl (4<sup>1</sup>/<sub>2</sub>oz)



**P359** Chopstick Rest



**Large Oval Bowl**  
**P126** 21.0cl (7<sup>1</sup>/<sub>2</sub>oz)



**Medium Low Bowl**  
**P122** 10.0cl (3<sup>3</sup>/<sub>4</sub>oz)  
**P132** Lid



**Gourmet Bowl**  
**P026** 9.0cm (3<sup>1</sup>/<sub>2</sub>"")  
 15.0cl (5oz)



**Gourmet Bowl**  
**P028** 7.0cm (2<sup>3</sup>/<sub>4</sub>"")  
 7.0cl (2<sup>1</sup>/<sub>2</sub>oz)

PATTERN CODE: 6300

PORCELAIN  
**ACCESSORIES™**



**Double Saucer**  
**P296** 20.0cm (8")



**Double Bowl**  
**P297** 19.0cm (7<sup>1</sup>/<sub>2</sub>"")  
 12.0cl & 6.0cl  
 (4oz & 2oz)



**Large Tumbler**  
**P262** 9.0cl (3oz)



**Small Tumbler**  
**P263** 5.25cl (1<sup>3</sup>/<sub>4</sub>oz)



**Pourer**  
**P264** 9.0cl (3oz)



**Deep Spoon**  
**P299** 12.7cm x 3.8cm  
 (5" x 1<sup>1</sup>/<sub>2</sub>"")

PATTERN CODE: 6302



# CRUCIAL DETAIL

## Ultimate style and design

Martin Kastner's diverse career began in an unconventional way, at a 16th century castle restoring historical metalworks in Western Bohemia. From blacksmithing to design to conceptual art projects, a common sense of function and aesthetics ties Kastner's work together. His unique chef driven pieces revolutionise the way we think about food.

The journey for Crucial Detail began in 2003 when Chef Grant Achatz contacted Kastner and a culinary collaboration was born. Their first project, a collapsible tripod for frozen hibiscus tea, profoundly resonated with guests and planted the seed to countless designs for the famed Alinea restaurant. Kastner also designed the showpieces for Team USA in 2015 & 2017 at the famed Bocuse d'Or Competition in Lyon, France. Additional collaborations with notable chefs including Laurent Gras, Wolfgang Puck and Alex Stupak have captivated the industry by creating entirely new and beautiful ways of presenting food.

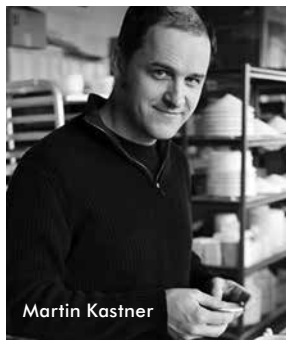

Martin Kastner

## For a distinctively graceful presentation

- cool blue-white porcelain
- uniquely designed
- chef driven pieces with forward style

## Crucial Detail

elegance has never looked so fascinating



*crucial detail*



CRUCIAL DETAIL  
**PLATEAU™**

### softly dipped delights

This timeless, subtle design seamlessly marries form and function creating a fresh take on a blank canvas for chefs everywhere. Elegant in its simplicity, this collection lifts the flat plate above the table's surface for ease of transport without compromising presentation. A subtle relief in the centre allows chefs to build on the high and low points of each piece, creating a gentle play of light and shadow on a pure geometric form.



**Plateau Plate**  
**P1209** 30.5cm (12")  
 6.0cm Rim (2<sup>3</sup>/<sub>8</sub>" Rim)  
**P1210** 30.5cm (12")  
 4.75cm Rim (1<sup>7</sup>/<sub>8</sub>" Rim)  
**P1211** 17.0cm (6<sup>5</sup>/<sub>8</sub>" )  
 4.0cm Rim (1<sup>1</sup>/<sub>2</sub>" Rim)



**Plateau Plate**  
**P1213** 28.0cm (11")  
 4.6cm Rim (1<sup>13</sup>/<sub>16</sub>" Rim)  
**P1214** 23.0cm (9")  
 4.1cm Rim (1<sup>7</sup>/<sub>8</sub>" Rim)



**Plateau Deep Plate**  
**P1212** 17.0cm (6<sup>3</sup>/<sub>8</sub>" )  
 4.0cm Rim (1<sup>1</sup>/<sub>2</sub>" Rim)



CRUCIAL DETAIL  
**BUFFET™**

**stylish single serving**

Innovative, unique serving pieces create a buffet or canapé experience to be anticipated and savoured.



**Miska Oval Bowl**  
P1203 18.5cm x 11.0cm  
(7<sup>3</sup>/<sub>8</sub>" x 4<sup>3</sup>/<sub>8</sub>" x 1<sup>5</sup>/<sub>8</sub>" )  
6.0cl (2oz)



**Sectional**  
P1204 4.5cm x 5.0cm  
(1<sup>3</sup>/<sub>4</sub>" x 1<sup>3</sup>/<sub>4</sub>" x 2")



**Antiplate**  
P1205 4.0cm W x 2.5cm H  
(2" Empty Well)



*crucial detail* **CRUCIAL DETAIL LANDSCAPE™**

**fabulous freeform finesse**

Unlike any other presentation items seen in the commercial foodservice industry, Martin Kastner's designs transform the way we eat through innovative, unique serving pieces. A true stand out of the collection, the Landscape series draws on unconventional, almost freeform curves in a liquid/solid type platform.



**Landscape Mounds**  
**P1201** 29.4cm x 20.8cm  
 (11<sup>1</sup>/<sub>2</sub>" x 8<sup>1</sup>/<sub>8</sub>")

**Landscape Dune**  
**P1202** 26.7cm x 26.7cm  
 (10<sup>1</sup>/<sub>2</sub>" x 10<sup>1</sup>/<sub>2</sub>")

**Landscape Plate Drift**  
**P1206** 14.0cm x 14.0cm  
 (5<sup>1</sup>/<sub>2</sub>" x 5<sup>1</sup>/<sub>2</sub>")

**Landscape Plate Dune**  
**P1207** 19.5cm x 19.5cm  
 (7<sup>3</sup>/<sub>4</sub>" x 7<sup>3</sup>/<sub>4</sub>")



**crucial detail** CRUCIAL DETAIL  
**PARENTHESSES™**

**crisp contained creations**

Bringing the chef's presentation to sharp focus is what first inspired the Parentheses collection by Crucial Detail. Just as attention is centred on wording within a parentheses in text, so is emphasis drawn to the food when plated on a Parentheses piece. Smooth, clean lines of each piece ensure the guest's attention to aesthetic is where it should be – your food.

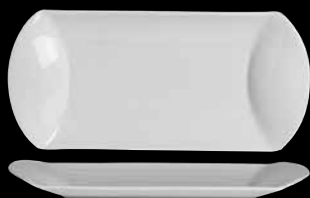

**Parentheses Platter**  
P1310 32.0cm x 16.5cm  
(12½" x 6½")



**Parentheses Cappuccino Cup**  
P1312 24.9cl (8¾oz)



**Parentheses Cappuccino Saucer**  
P1313 15.5cm (6½")



**Parentheses Espresso Cup**  
P1314 7.8cl (2¾oz)



**Parentheses Espresso Saucer**  
P1315 11.5cm (4⅝")



**Parentheses Jug**  
P1316 XS 5.5cl (2oz)  
P1317 S 12.8cl (4½oz)  
P1318 M 20.6cl (7¼oz)  
P1319 L 21.25cl (11oz)



### small saucy sides

Café Porcelain is packed with features and benefits at a price point that will allow even the most value conscious operator to serve up a four star presentation. This multi-faceted range works well in all decors, from traditional to contemporary. When it comes to value, beauty and performance, Café Porcelain truly is your solution.



**Rectangle Tray Handled**  
**E404** 33.0cm x 16.5cm  
 (13" x 6½")  
**E405** 30.0cm x 14.5cm  
 (11¾" x 5¾")  
**E406** 25.0cm x 12.3cm  
 (10" x 4 7/8")  
**E407** 20.0cm x 10.0cm  
 (8" x 4")



**Square Tray Handled**  
**E424** 15.0cm (6")



**Square Plate**  
**E570** 8.9cm (3½")



**Square Dish**  
**E544** 11.0cm (4½")  
 7.4cl (2½oz)



**Square Sauce Dish**  
**E545** 7.6cm (3")  
 1.5cl (½oz)



**Square Bowl**  
**E590** 8.25cm (3¼")



**Square Bowl**  
**E417** 10.0cm x 4.2cm H  
 (4" x 1½")  
 19.0cl (6¼oz)

**E419** 13.3cm x 3.8cm H  
 (5¼" x 1½")  
 62.0cl (20¾oz)



**Square Ramekin**  
**E421** 8.25cm x 4.2cm H  
 (3¼" x 1½")  
 20.0cl (6¾oz)

**E422** 5.7cm x 3.2cm H  
 (2¼" x 1¼")  
 7.0cl (2¼oz)



**Square Ramekin**  
**E566** 5.1cm (2" x 1")  
 2.2cl (¾oz)  
**E567** 7.9cm (3⅛" x 1⅛")  
 8.2cl (2¾oz)  
**E568** 10.1cm (4" x 1¼")  
 16.2cl (5½oz)



**Square Bowl**  
**E571** 9.2 x 9.2 x 5.0cm  
 (3⅝" x 3⅝" x 2")



**Square Deep Ramekin**  
**E593** 5.4cm (2")  
**E594** 3.8cm (1½")



**Round Deep Ramekin**  
**E591** 7.9cm (3⅛")  
**E592** 5.7cm (2¼")



**Rectangle Bowl**  
**E414** 14.8 x 10.8 x 4.7cm  
 (5 7/8" x 4¼" x 1 7/8")  
 35.0cl (11¾oz)



**Deep Rectangle Tray**  
**E423** 19.0 x 14.5 x 4.5cm  
 (7⅝" x 5¾" x 1⅝")



**Rectangle Tray**  
**E569** 19.7 x 10.5 x 2.5cm  
 (7¾" x 4⅛" x 1")  
 29.8cl (10½oz)



**Rectangle Tray**  
**E596** 8.25cm (3¼")



**Rectangle Deep Tray**  
**E580** 17.5cm x 13.0cm  
 (6⅞" x 5⅛")



**Double Well Rectangle Tray**  
**E595** 14.6cm (5¾")



**Oval Bowl**  
**E585** 10.2cm (4")  
**E586** 15.25cm (6")  
**E587** 20.3cm (7⅞")  
**E588** 25.4cm (9⅞")



**Chip Bowl** NEW  
**E533** 13.0 x 10.0 x 9.5cm (h)  
 (5" x 4" x 3¾" (h))  
 34.0cl (12oz)



# CUTLERY

The right cutlery can bring a whole new dimension to your tabletop. With Folio, Varick, Robert Welch and Laguiole our specialist partners, we have designers of fine cutlery who perfectly mirror our own exacting standards.

By forging a partnership with these leading names we are able to bring you an exceptional choice of stylish cutlery for any style of venue. From elegant to modern, we have a comprehensive selection of designs to suit your needs. Crafted from either 18/10 stainless steel for optimum strength, high shine and excellent stain resistance, or 18/0 for the value-conscious operator, there is a cutlery collection to suit the ambience of any dining occasion.







### Perfect for any venue

Introducing the Folio Collection; a contemporary assortment of cutlery that is perfect for any size operator. Conveniently priced with the operators in mind, this collection features clean, sleek lines and boasts an 18/10 stainless steel finish. Folio cutlery provides excellent stain and rust resistance with a long lasting shine, making it a great choice for your banqueting and dining needs.





FOLIO  
HARTMAN™

NEW RANGE

Simple, yet timeless, the high quality mirror finish of Hartman provides a look that is ideal for any venue.

- 18/10 stainless steel
- Dishwasher safe



Dinner Knife **NEW**  
SX042 24.13cm (9½")



Butter Knife **NEW**  
SX045 17.78cm (7")



Dessert Knife **NEW**  
SX051 20.0cm (7¾")



Steak Knife **NEW**  
SX056 23.81cm (9¾")



Dinner Fork **NEW**  
SX021 20.64cm (8¼")



Dessert/Salad Fork **NEW**  
SX023 17.15cm (6¾")



Cocktail Fork **NEW**  
SX025 14.61cm (5¾")



Oval Bowl Soup/  
Dessert Spoon **NEW**  
SX003 20.32cm (8")



Bouillon Soup Spoon **NEW**  
SX002 18.1cm (7¼")



A.D. Coffee Spoon **NEW**  
SX005 13.97cm (5½")



A.D. Coffee Spoon **NEW**  
SX008 11.11cm (4¾")



Iced Tea Spoon **NEW**  
SX006 20.0cm (7¾")



Serving Spoon **NEW**  
SX061 22.86cm (9")

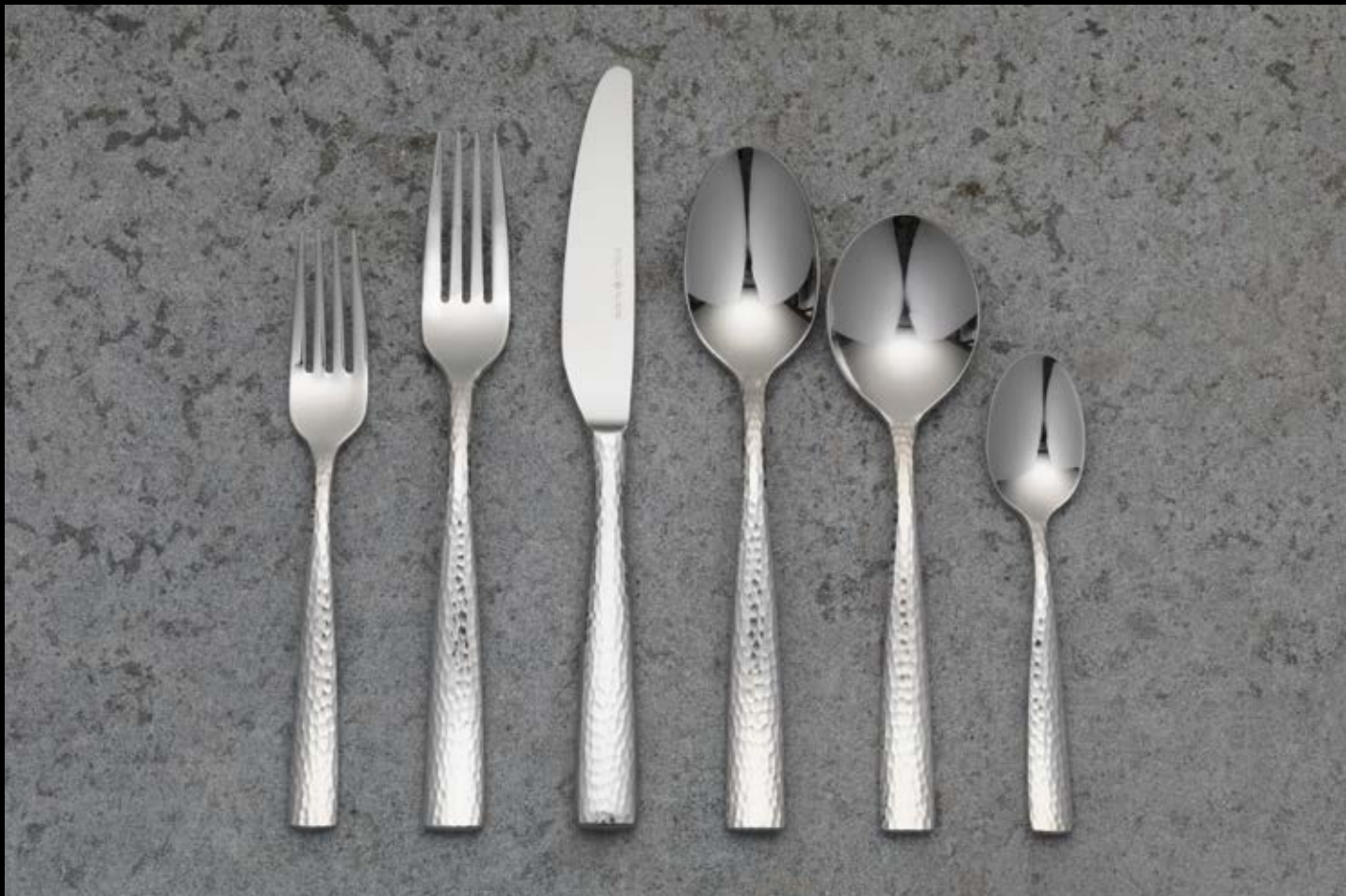

FOLIO  
ALISON™

NEW RANGE

A beautiful mirrored hammered pattern that is whimsical and bold.

- 18/10 stainless steel
- High quality mirror polished finish



Dinner Knife **NEW**  
SX042 23.2cm (9<sup>1</sup>/<sub>8</sub>"



Butter Knife **NEW**  
SX045 17.8cm (7"



Dessert Knife **NEW**  
SX051 20.0cm (7<sup>7</sup>/<sub>8</sub>"



Steak Knife **NEW**  
SX056 23.5cm (9<sup>1</sup>/<sub>4</sub>"



Dinner Fork **NEW**  
SX021 20.6cm (8<sup>1</sup>/<sub>8</sub>"



Dessert/Salad Fork **NEW**  
SX023 17.5cm (6<sup>7</sup>/<sub>8</sub>"



Cocktail Fork **NEW**  
SX025 14.6cm (5<sup>3</sup>/<sub>4</sub>"



Oval Bowl Soup/  
Dessert Spoon **NEW**  
SX003 20.0cm (7<sup>7</sup>/<sub>8</sub>"



Bouillon Soup Spoon **NEW**  
SX002 18.1cm (7<sup>1</sup>/<sub>8</sub>"

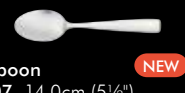

Teaspoon **NEW**  
SX007 14.0cm (5<sup>1</sup>/<sub>2</sub>"



A.D. Coffee Spoon **NEW**  
SX005 11.1cm (4<sup>3</sup>/<sub>8</sub>"

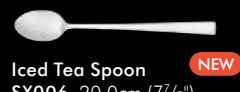

Iced Tea Spoon **NEW**  
SX006 20.0cm (7<sup>7</sup>/<sub>8</sub>"



Serving Spoon **NEW**  
SX061 22.9cm (9"



FOLIO  
BRYCE™

NEW RANGE

With a modern look, Bryce is designed for all banqueting environments, easy to care for and beautifully elegant.

- 18/10 stainless steel
- High quality mirror polished finish
- Designed for banqueting



Dinner Knife **NEW**  
SX042 23.5cm (9¼")



Butter Knife **NEW**  
SX045 17.8cm (7")



Dessert Knife **NEW**  
SX051 20.0cm (7⅞")



Steak Knife **NEW**  
SX056 23.5cm (9¼")



Dinner Fork **NEW**  
SX021 20.6cm (8⅛")



Dessert/Salad Fork **NEW**  
SX023 17.5cm (6⅞")



Cocktail Fork **NEW**  
SX025 14.6cm (5¾")



Oval Bowl Soup/  
Dessert Spoon **NEW**  
SX003 20.0cm (7⅞")



Bouillon Soup Spoon **NEW**  
SX002 18.1cm (7⅛")



Teaspoon **NEW**  
SX007 14.0cm (5½")



A.D. Coffee Spoon **NEW**  
SX005 11.1cm (4⅜")



Iced Tea Spoon **NEW**  
SX006 20.0cm (7⅞")



Serving Spoon **NEW**  
SX061 22.9cm (9")



FOLIO  
PIROUETTE™

NEW RANGE

Horizontal lines on the length of the handles give the Pirouette pattern by Folio an elegantly coiled design while minimising the appearance of fingerprints.

- 18/10 stainless steel
- High quality mirror polished finish



Dinner Knife **NEW**  
SX042 23.5cm (9¼")



Butter Knife **NEW**  
SX045 17.8cm (7")



Dessert Knife **NEW**  
SX051 20.0cm (7⅞")



Steak Knife **NEW**  
SX056 23.5cm (9¼")



Dinner Fork **NEW**  
SX021 20.6cm (8⅛")



Dessert/Salad Fork **NEW**  
SX023 17.5cm (6⅞")



Cocktail Fork **NEW**  
SX025 14.6cm (5¾")



Oval Bowl Soup/  
Dessert Spoon **NEW**  
SX003 20.0cm (7⅞")



Bouillon Soup Spoon **NEW**  
SX002 18.1cm (7⅛")



Teaspoon **NEW**  
SX007 14.0cm (5½")



A.D. Coffee Spoon **NEW**  
SX005 11.1cm (4⅜")



Iced Tea Spoon **NEW**  
SX006 20.0cm (7⅞")



Serving Spoon **NEW**  
SX061 22.9cm (9")





# VARICK

## Designed specifically for the hospitality industry

The Varick Collection includes patterns made from 18/0 stainless steel, all exceptionally priced for value-conscious operators. Top-grade hand polishing provides a superior soft shine, while proper weight distribution and balance provides a comfortable feel when handling. Complete with a collection of steak knives, Varick cutlery is dishwasher safe and offers a breadth of patterns at an affordable price, making it the ideal choice for the hospitality industry.





VARICK  
**MARNEE™**

**NEW RANGE**

Extraordinarily simple, the delicate Marnee collection features slender handles with a mirror finish and a subtle linear accent at the base.

- 18/0 stainless steel



Dinner Knife **NEW**  
SX042 23.18cm (9<sup>1</sup>/<sub>8</sub>"



Dinner Fork **NEW**  
SX021 20.48cm (8<sup>1</sup>/<sub>8</sub>"



Dessert/Salad Fork **NEW**  
SX023 18.1cm (7<sup>1</sup>/<sub>8</sub>"



Oval Bowl Soup/  
Dessert Spoon **NEW**  
SX003 18.1cm (7<sup>1</sup>/<sub>8</sub>"



Bouillon Soup Spoon **NEW**  
SX002 16.51cm (6<sup>1</sup>/<sub>2</sub>"



Teaspoon **NEW**  
SX001 15.56cm (6<sup>1</sup>/<sub>8</sub>"



A.D. Coffee Spoon **NEW**  
SX008 11.11cm (4<sup>3</sup>/<sub>8</sub>"



VARICK  
**AVINA™**

**NEW RANGE**

Avina's classy, curvy and slender handles make this delicate pattern a striking addition to the table scape.

- 18/0 stainless steel



Dinner Knife **NEW**  
SX042 23.5cm (9¼")



Oval Bowl Soup/  
Dessert Spoon **NEW**  
SX003 18.1cm (7<sup>1</sup>/<sub>8</sub>")



Dinner Fork **NEW**  
SX021 20.48cm (8<sup>1</sup>/<sub>16</sub>")



Bouillon Soup Spoon **NEW**  
SX002 16.51cm (6½")



Dessert/Salad Fork **NEW**  
SX023 18.4cm (7¼")



Teaspoon **NEW**  
SX001 15.24cm (6")



A.D. Coffee Spoon **NEW**  
SX008 11.11cm (4<sup>3</sup>/<sub>8</sub>")



VARICK  
**DISTRESSED BRIAR™**

**NEW RANGE**

Distressed to perfection, Briar features a weathered look that serves as a great complement to your casual dining presentation.

- 18/0 stainless steel
- Distressed finish that reduces the appearance of fingerprints



Dinner Knife  
 SX042 22.9cm (9") **NEW**



Oval Bowl Soup/  
 Dessert Spoon  
 SX003 20.3cm (8") **NEW**



Dinner Fork  
 SX021 20.3cm (8") **NEW**



Bouillon Soup Spoon **NEW**  
 SX002 16.5cm (6½")

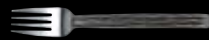

Dessert/Salad Fork **NEW**  
 SX023 17.8cm (7")



Teaspoon **NEW**  
 SX007 14.0cm (5½")



Demitasse Spoon **NEW**  
 SX008 11.1cm (4¾")



VARICK  
**FULTON VINTAGE  
 COPPER™**

**NEW RANGE**

Take the tabletop to the next level with this memorable collection in a vintage copper finish. Combine with Fulton Vintage for a truly unique look.

- 18/0 stainless steel
- Stylish and distinct



Dinner Knife **NEW**  
 SX042 24.1cm (9½")



Oval Bowl Soup/  
 Dessert Spoon **NEW**  
 SX003 20.3cm (8")



Dinner Fork **NEW**  
 SX021 20.3cm (8")



Bouillon Soup Spoon **NEW**  
 SX002 17.8cm (7")



Dessert/Salad Fork **NEW**  
 SX023 17.8cm (7")



Teaspoon **NEW**  
 SX007 14.0cm (5½")



Demitasse Spoon **NEW**  
 SX008 11.1cm (4¾")



VARICK  
**FULTON VINTAGE™**

**NEW RANGE**

The classic shape and vintage finish of this collection gives any tabletop a stylish and distinct look.

- 18/0 stainless steel
- Classic shape



Dinner Knife **NEW**  
 SX042 24.1cm (9½")



Dinner Fork **NEW**  
 SX021 20.3cm (8")



Dessert/Salad Fork **NEW**  
 SX023 17.8cm (7")



Oval Bowl Soup/  
 Dessert Spoon **NEW**  
 SX003 20.3cm (8")



Bouillon Soup Spoon **NEW**  
 SX002 17.8cm (7")



Teaspoon **NEW**  
 SX007 14.0cm (5½")



Demitasse Spoon **NEW**  
 SX008 11.1cm (4¾")



VARICK  
**ORIGIN™**

18/0 cutlery which is exceptionally priced for value-conscious operators. Varick cutlery provides excellent stain and rust resistance, all the while being commercial dishwasher safe, making it the ideal choice for the hospitality industry.



**Table Knife**  
SX042 23.5cm (9¼")



**Soup Spoon**  
SX002 19.3cm (7½")



**Dessert Knife**  
SX045 18.4cm (7¼")



**Dessert Spoon**  
SX003 19.0cm (7½")



**Table Fork**  
SX021 20.6cm (8¼")



**Tea Spoon**  
SX001 15.5cm (6¼")



**Dessert Fork**  
SX023 18.7cm (7¾")



VARICK  
**STEAK KNIVES™**

NEW ADDITION



Available in various handle options and either sharpened or serrated, round or pointed blades. Varick steak knives add that “something extra” to tabletop presentations.



**5792WP056**  
11.4cm (4½")  
Tapered Serrated Blade -  
ABS Handle

NEW



**5793WP059**  
25.0cm (9⅞") 13.0cm (5")  
Rounded Serrated Blade  
POM Black Handle W/Rivets



**5790WP077**  
24.0cm (9½") 12.0cm (4¾")  
Tapered Sharpened Blade S/S  
Satin Handle



**5794WP057**  
25.0cm (9⅞") 13.0cm (5")  
Tapered Serrated Blade  
Pineapple Wood Handle W/Rivets



**5791WP077**  
24.0cm (9½") 12.0cm (4¾")  
Tapered Sharpened Blade  
Black ABS Handle



**5794WP059**  
25.0cm (9⅞") 13.0cm (5")  
Rounded Serrated Blade  
Pineapple Wood Handle W/Rivets



**5795WP059**  
25.0cm (9⅞") 13.0cm (5")  
Rounded Serrated Blade  
Red Pakka Wood Handle W/Rivets



JEAN DUBOST  
**LAGUIOLE™**

NEW ADDITIONS



Sharpened to perfection, the stainless steel cheese knives by Jean Dubost are a beautiful accessory to any buffet presentation. Available in four different shapes, the knives are a great mix and match, and the vintage finish provides a trendy, contemporary look.



**Spreader**  
53858S033 SS Handle  
15.0cm (6")

NEW

**Spreader**  
5402S033 Vintage SS Handle  
15.0cm (6")

NEW

**Spreader**  
5398S033 Olivewood Handle  
15.0cm (6")

NEW



**Parmesan Cheese Knife**  
53858S034 SS Handle  
19.0cm (7½")

NEW

**Parmesan Cheese Knife**  
5402S034 Vintage SS Handle  
19.0cm (7½")

NEW

**Parmesan Cheese Knife**  
5398S034 Olivewood Handle  
19.0cm (7½")

NEW

**Steak Knife Presentation Block**  
5403S031 Lightwood  
5.8 x 5.3 x 12.9cm  
(2¼" x 2" x 5")

NEW

5403S032 Black  
5.8 x 5.3 x 12.9cm  
(2¼" x 2" x 5")

NEW

**Cheese Cleaver**  
53858S030 SS Handle  
21.3cm (8⅜")

NEW

**Cheese Cleaver**  
5402S030 Vintage SS Handle  
21.3cm (8⅜")

NEW



**Cheese Knife**  
53858S163 SS Handle  
23.0cm (9")

NEW

**Cheese Knife**  
5402S163 Vintage SS Handle  
23.0cm (9")

NEW

**Cheese Knife**  
5398S163 Olivewood Handle  
**Cheese Board w/ Magnetic Part**  
5398S029 Olivewood  
29.8cm x 14.0cm  
(11¾" x 5½")

NEW

NEW

**Beechwood Presentation Box**  
5396S099 26.0 x 14.0 x 3.5cm  
(10¼" x 5½" x 1½")

NEW

**Steak Knife Serrated 1.2mm Blade**  
5402S057 Vintage SS Handle  
22.9cm (9")

NEW

**Stand Up 1.2mm Blade**  
53855S160 Dark Blue ABS Handle

**Stand Up 1.2mm Blade**  
53856S160 Grey ABS Handle

**Stand Up 1.2mm Blade**  
53857S160 Ivory ABS Handle

**Steak Knife Serrated 1.2mm Blade**  
53852S057 Pepper SS & ABS  
Forged Handle

**Steak Knife Serrated 1.2mm Blade**  
53853S057 Taupe SS & ABS Forged  
Handle

**Steak Knife Serrated 1.2mm Blade**  
53854S057 White SS & ABS Forged  
Handle

**Black Handle Steak Knife**  
5392S057 Serrated 1.2mm  
S/S Blade

**Horn Handle Steak Knife**  
5394S057 Serrated 1.2mm  
S/S Blade

**Ivory Handle Steak Knife**  
5393S057 Serrated 1.2mm  
S/S Blade

**Steak Knife**  
5390S057 Serrated 1.2mm  
S/S Blade

**Oak Handle Steak Knife**  
5391S057 with Serrated 1.2mm  
S/S Blade



# ROBERT WELCH

Founded in 1955 by Robert Welch, Robert Welch Designs is a family run business based at Chipping Campden in the Cotswolds. Originally Robert Welch set up as a designer for industry from his workshop in Chipping Campden and from his base opened a shop to sell his own designs. Over the last fifteen years his family – Rupert Welch and Alice Welch (Directors) have expanded the business to supply hospitality customers with a multi award-winning collection of internationally renowned cutlery and tabletop items.

*Robert Welch*®



 ROBERT WELCH  
**BAGUETTE™**
**NEW RANGE**

Baguette is a classic shape that is versatile to both casual and fine dining. Comfort in the hand is a Robert Welch signature and the pebble smooth finish is soft to the grip. The thickness of the handle tapers towards the tip, keeping the weight centrally balanced.

Finish: Bright/Vintage  
 Gauge: 3.5mm

\* Indicates Bright stocked items.  
 All Vintage items in this range  
 are non-stock.



Table Knife\* **NEW**  
SX042 24.3cm (9.57")



Steak Knife **NEW**  
SX056 24.6cm (9.69")



Dessert Knife\* **NEW**  
SX051 22.5cm (8.86")



Fish Knife\* **NEW**  
SX049 22.2cm (8.74")



Butter Knife **NEW**  
SX045 16.0cm (6.3")



Table Fork\* **NEW**  
SX021 20.6cm (8.11")



Dessert Fork\* **NEW**  
SX023 18.5cm (7.28")



Pastry Fork **NEW**  
SX068 16.0cm (6.3")



Soup Spoon\* **NEW**  
SX002 20.1cm (7.91")



Dessert Spoon\* **NEW**  
SX003 18.5cm (7.28")



Round Bowl Soup Spoon **NEW**  
SX075 18.1cm (7.13")



Teaspoon\* **NEW**  
SX007 13.7cm (5.39")



US Teaspoon **NEW**  
SX001 15.8cm (6.22")



Coffee Spoon\* **NEW**  
SX005 10.5cm (4.13")



Iced Tea Spoon **NEW**  
SX006 20.0cm (7.87")



Serving Spoon **NEW**  
SX061 23.5cm (9.25")



Serving Fork **NEW**  
SX072 24.1cm (9.49")



Pie Server **NEW**  
SX031 25.3cm (9.96")

\* Indicates Bright stocked items.  
All Vintage items in this range are non-stock.  
Stock - Lead time maximum 20 working days.  
Non stock - Lead time maximum 25 working days.

The logo for Robert Welch, featuring the brand name in a cursive script.

ROBERT WELCH

BUD™

NEW RANGE



Bud cutlery has a slender handled design which curves elegantly into the palm of the hand. Spoons and forks are made using the highest quality 18/10 stainless steel. Knife blades are made from specially hardened stainless steel to provide the finest possible cutting edge.

Finish: Bright

Gauge: 5mm

All items in this range are non-stock.



**Table Knife** NEW  
 SX042 24.3cm (9.57")



**Soup Spoon** NEW  
 SX002 22.1cm (8.7")



**Steak Knife** NEW  
 SX056 25.5cm (10.04")



**Dessert Spoon** NEW  
 SX003 19.9cm (7.83")



**Dessert Knife** NEW  
 SX051 21.0cm (8.27")



**Teaspoon** NEW  
 SX007 14.7cm (5.79")



**Fish Knife** NEW  
 SX049 22.7cm (8.94")



**Coffee Spoon** NEW  
 SX005 11.2cm (4.41")



**Butter Knife** NEW  
 SX045 16.0cm (6.3")



**Iced Tea Spoon** NEW  
 SX006 20.4cm (8.03")



**Table Fork** NEW  
 SX021 22.1cm (8.7")



**Dessert Fork** NEW  
 SX023 19.9cm (7.83")



**Serving Spoon** NEW  
 SX061 28.7cm (11.3")



**Mini Fork** NEW  
 SX027 15.0cm (5.91")



**Serving Fork** NEW  
 SX072 28.8cm (11.34")

All items in this range are non-stock.  
 Stock - Lead time maximum 20 working days. Non stock - Lead time maximum 25 working days.

PATTERN CODE: 5984

Robert Welch.

ROBERT WELCH

HONEYBOURNE™

NEW RANGE



Inspired by the traditional silversmith technique of planishing, the Honeybourne collection makes a tactile and light reflecting statement on the table. Featuring classic proportions of long tines and a traditional heel, the deliberately thin neck exaggerates the wide curves of the subtly textured handle. The feel in the hand is well-considered as the texture fades to smooth at the neck of each piece.

Finish: Bright Hammered  
Gauge: 5mm

\* Indicates stocked items.



Table Knife\* **NEW**  
SX042 23.8cm (9.37")



Soup Spoon\* **NEW**  
SX002 18.0cm (7.09")



Steak Knife **NEW**  
SX056 24.2cm (9.53")



Dessert Spoon\* **NEW**  
SX003 15.9cm (6.26")



Dessert Knife\* **NEW**  
SX051 21.0cm (8.27")



Teaspoon\* **NEW**  
SX007 13.4cm (5.28")



Butter Knife **NEW**  
SX045 16.0cm (6.3")



US Teaspoon **NEW**  
SX001 20.4cm (8.03")



Table Fork\* **NEW**  
SX021 20.4cm (8.03")



Coffee Spoon\* **NEW**  
SX005 10.5cm (4.13")



Dessert Fork\* **NEW**  
SX023 18.0cm (7.09")



Iced Tea Spoon **NEW**  
SX006 20.0cm (7.87")



Serving Spoon **NEW**  
SX061 25.1cm (9.88")



Serving Fork **NEW**  
SX072 25.3cm (9.96")

\* Indicates stocked items.

Stock - Lead time maximum 20 working days. Non stock - Lead time maximum 25 working days.

Robert Welch.

ROBERT WELCH  
KINGHAM™

NEW RANGE



Kingham cutlery exhibits a clean and elegant profile and a contemporary classic aesthetic. Kingham is suited to both casual and fine dining.

Finish: Bright  
Gauge: 3.5mm

\* Indicates stocked items.



Table Knife\* **NEW**  
SX042 24.0cm (9.45")

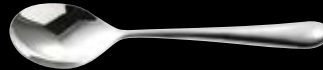

Soup Spoon\* **NEW**  
SX002 20.2cm (7.95")



Steak Knife **NEW**  
SX056 24.0cm (9.45")



Dessert Spoon\* **NEW**  
SX003 18.2cm (7.17")



Dessert Knife\* **NEW**  
SX051 21.5cm (8.46")



Teaspoon\* **NEW**  
SX007 13.3cm (5.24")



Butter Knife **NEW**  
SX045 16.0cm (6.3")



US Teaspoon **NEW**  
SX001 16.0cm (6.3")



Table Fork\* **NEW**  
SX021 20.2cm (7.95")



Coffee Spoon\* **NEW**  
SX005 10.5cm (4.13")



Dessert Fork\* **NEW**  
SX023 18.1cm (7.13")



Iced Tea Spoon **NEW**  
SX006 20.0cm (7.87")



Serving Spoon **NEW**  
SX061 23.0cm (9.06")



Serving Fork **NEW**  
SX072 23.0cm (9.06")

\* Indicates stocked items.

Stock - Lead time maximum 20 working days. Non stock - Lead time maximum 25 working days.

ROBERT WELCH  
**MALVERN™****NEW RANGE**

Inspired by nature, the Malvern collection has gentle contours that flare to a slightly curved base. Each piece has been designed for a substantial feel and weight and has a real presence at the table.

Finish: Bright  
Gauge: 3.5mm

\* Indicates stocked items.



Table Knife\* **NEW**  
SX042 24.5cm (9.65")



Steak Knife **NEW**  
SX056 24.5cm (9.65")



Dessert Knife\* **NEW**  
SX051 22.3cm (8.78")



Butter Knife **NEW**  
SX045 15.0cm (5.91")



Table Fork\* **NEW**  
SX021 20.8cm (8.19")



Dessert Fork\* **NEW**  
SX023 19.2cm (7.56")



Pastry Fork **NEW**  
SX068 16.2cm (6.38")



Childs Knife **NEW**  
SX032 17.6cm (6.93")



Childs Fork **NEW**  
SX033 15.0cm (5.91")



Childs Spoon **NEW**  
SX034 14.8cm (5.83")



Soup Spoon\* **NEW**  
SX002 20.9cm (8.23")



Round Bowl Soup Spoon **NEW**  
SX075 18.0cm (7.09")



Dessert Spoon\* **NEW**  
SX003 19.0cm (7.48")



Teaspoon\* **NEW**  
SX007 13.7cm (5.39")



US Teaspoon **NEW**  
SX001 16.0cm (6.3")



Coffee Spoon\* **NEW**  
SX005 10.4cm (4.09")



Iced Tea Spoon **NEW**  
SX006 20.5cm (8.07")



Serving Spoon **NEW**  
SX061 25.2cm (9.92")



Serving Fork **NEW**  
SX072 25.0cm (9.84")



Gourmet Serving Spoon **NEW**  
SX080 25.4cm (10")



Sauce Ladle **NEW**  
SX065 16.7cm (6.57")



Pie Server **NEW**  
SX031 25.3cm (9.96")

\* Indicates stocked items.

Stock - Lead time maximum 20 working days. Non stock - Lead time maximum 25 working days.

PATTERN CODE: 5971

Robert Welch.

ROBERT WELCH

RADFORD™

NEW RANGE



Considered by some to be 'perfection in the hand'. The Radford collection has a softness and ergonomic curve which is both classic and contemporary. The Radford design is versatile enough to complement any table setting.

Finish: Bright/Satin  
Gauge: 5mm

\* Indicates Bright stocked items.  
All Satin items in this range are non-stock.



Table Knife\* **NEW**  
SX042 24.2cm (9.53")



Table Fork\* **NEW**  
SX021 20.5cm (8.07")



Soup Spoon\* **NEW**  
SX002 20.0cm (7.87")



Steak Knife\* **NEW**  
SX056 24.9cm (9.8")



Dessert Fork\* **NEW**  
SX023 17.8cm (7.01")



Dessert Spoon\* **NEW**  
SX003 17.5cm (6.89")



Dessert Knife\* **NEW**  
SX051 21.6cm (8.5")



Pastry Fork\* **NEW**  
SX068 16.3cm (6.42")



Teaspoon\* **NEW**  
SX007 14.2cm (5.59")



Fish Knife\* **NEW**  
SX049 21.9cm (8.62")



Fish Fork\* **NEW**  
SX029 19.3cm (7.6")



Coffee Spoon\* **NEW**  
SX005 11.7cm (4.61")



Butter Knife\* **NEW**  
SX045 14.8cm (5.83")



Iced Tea Spoon\* **NEW**  
SX006 21.0cm (8.27")



Cheese Knife\* **NEW**  
SX039 20.6cm (8.11")

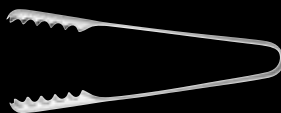

Ice Tongs\* **NEW**  
SX073 17.0cm (6.69")



Serving Spoon\* **NEW**  
SX061 23.0cm (9.06")



Small Cheese Set 4P **NEW**  
SX268 21.0cm (8.27")



Sugar Tongs\* **NEW**  
SX317 10.8cm (4.25")



Serving Fork\* **NEW**  
SX072 23.5cm (9.25")

\* Indicates Bright stocked items.  
All Satin items in this range are non-stock.  
Stock - Lead time maximum 20 working days.  
Non stock - Lead time maximum 25 working days.





Fruit Knife **NEW**  
SX185 18.5cm (7.28")



Butter Blade **NEW**  
SX046 17.0cm (6.69")



Spreader **NEW**  
SX047 14.8cm (5.83")



Cake Knife **NEW**  
SX024 31.6cm (12.44")



Small Cheese Knife **NEW**  
SX191 14.8cm (5.83")



All Purpose Cheese Knife **NEW**  
SX182 22.0cm (8.66")



Soft Cheese Knife **NEW**  
SX040 22.5cm (8.86")



Hard Cheese Knife **NEW**  
SX030 19.5cm (7.68")



Cheese Chisel **NEW**  
SX183 17cm (6.69")



Stilton Scoop **NEW**  
SX265 20.0cm (7.87")



Stilton Scoop **NEW**  
SX266 20.0cm (7.87")



Cheese Knife **NEW**  
Gourmet Set 5P  
SX181 29.0cm (11.42")



Spork **NEW**  
SX264 17.5cm (6.89")



Canape Fork **NEW**  
SX025 14.2cm (5.59")



Oyster Fork **NEW**  
SX038 16.0cm (6.3")



Snail Fork **NEW**  
SX192 13.6cm (5.35")



Snail Tongs **NEW**  
SX194 17.3cm (6.81")

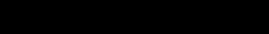

Lobster Pick **NEW**  
SX028 21.4cm (8.43")



Childs Knife **NEW**  
SX032 16.2cm (6.38")



Childs Fork **NEW**  
SX033 14.9cm (5.87")



Childs Spoon **NEW**  
SX034 14.9cm (5.87")



Round Bowl Soup Spoon **NEW**  
SX075 17.1cm (6.73")



Grapefruit Spoon **NEW**  
SX186 14.4cm (5.67")



Olive/Pickle Spoon **NEW**  
SX189 16.8cm (6.61")



Condiment Spoon **NEW**  
SX184 7.4cm (2.91")



Sauce Spoon **NEW**  
SX014 17.9cm (7.05")



Ice Cream / Gelato Spoon **NEW**  
SX187 15.0cm (5.91")



US Teaspoon **NEW**  
SX001 16.0cm (6.3")



Espresso Spoon **NEW**  
SX079 10.5cm (4.13")



Gourmet Serving Spoon **NEW**  
SX080 25.7cm (10.12")

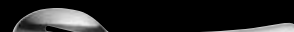

Slotted Spoon **NEW**  
SX060 27.0cm (10.63")



Salad Serving Spoon **NEW**  
SX062 27.0cm (10.63")



Salad Serving Fork **NEW**  
SX071 26.4cm (10.39")



Pie Server **NEW**  
SX031 25.0cm (9.84")

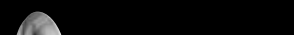

Soup Ladle **NEW**  
SX063 32.0cm (12.6")

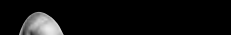

Sauce Ladle **NEW**  
SX065 17.0cm (6.69")



Ice Scoop **NEW**  
SX188 21.4cm (8.43")



Serving Tongs **NEW**  
SX190 23.4cm (9.21")



Carving Knife **NEW**  
SX035 33.0cm (12.99")



Carving Fork **NEW**  
SX036 30.0cm (11.81")



Carving Set **NEW**  
SX180 41.0cm (16.14")

\* Indicates Bright stocked items.  
All Satin items in this range are non-stock.  
Stock - Lead time maximum 20 working days.  
Non stock - Lead time maximum 25 working days.



ROBERT WELCH

RW2™

NEW RANGE



Designed with a Scandinavian feel and influence, the RW2 range is based on a Robert Welch mid-century design – Alverston – noted as an evolutionary design based on ideal form.

Finish: Bright/Satin  
Gauge: 4mm

\* Indicates Bright stocked items.  
All Satin items in this range are non-stock.



Table Knife\* **NEW**  
SX042 23.8cm (9.37")



Soup Spoon\* **NEW**  
SX002 20.0cm (7.87")



Steak Knife **NEW**  
SX056 24.0cm (9.45")



Dessert Spoon\* **NEW**  
SX003 19.0cm (7.48")



Dessert Knife\* **NEW**  
SX051 20.8cm (8.19")



Teaspoon\* **NEW**  
SX007 13.4cm (5.28")



Fish Knife **NEW**  
SX049 22.2cm (8.74")



Coffee Spoon\* **NEW**  
SX005 11.8cm (4.65")



Butter Blade **NEW**  
SX047 17.0cm (6.69")



Iced Tea Spoon **NEW**  
SX006 20.1cm (7.91")



Table Fork\* **NEW**  
SX021 20.8cm (8.19")



Serving Spoon **NEW**  
SX061 22.8cm (8.98")



Dessert Fork\* **NEW**  
SX023 18.6cm (7.32")



Pastry Fork **NEW**  
SX068 16.5cm (6.5")



Serving Fork **NEW**  
SX072 23.6cm (9.29")



Childs Knife **NEW**  
SX032 16.3cm (6.42")



Salad Server (Left) **NEW**  
SX062 27.0cm (10.63")



Childs Fork **NEW**  
SX033 15.2cm (5.98")



Salad Server (Right) **NEW**  
SX071 26.8cm (10.55")



Childs Spoon **NEW**  
SX034 14.8cm (5.83")

\* Indicates Bright stocked items.  
All Satin items in this range are non-stock.  
Stock - Lead time maximum 20 working days.  
Non stock - Lead time maximum 25 working days.

The logo for Robert Welch, featuring the brand name in a cursive script.ROBERT WELCH  
**STANTON™****NEW RANGE**

Stanton cutlery is an example of beautiful and exact sculpture; well-balanced and comfortable to use.

Finish: Bright/Satin  
Gauge: 5mm

\* Indicates Bright stocked items.  
All Satin items in this range are non-stock.



Table Knife\* **NEW**  
SX042 23.3cm (9.17")



Soup Spoon\* **NEW**  
SX002 19.6cm (7.72")



Steak Knife **NEW**  
SX056 23.7cm (9.33")



Dessert Spoon\* **NEW**  
SX003 17.6cm (6.93")



Dessert Knife\* **NEW**  
SX051 22.0cm (8.66")



Teaspoon\* **NEW**  
SX007 14.1cm (5.55")



Butter Knife **NEW**  
SX045 14.7cm (5.79")



US Teaspoon **NEW**  
SX001 16.2cm (6.38")



Table Fork\* **NEW**  
SX021 20.1cm (7.91")



Coffee Spoon\* **NEW**  
SX005 11.5cm (4.53")



Dessert Fork\* **NEW**  
SX023 18.1cm (7.13")



Espresso Spoon **NEW**  
SX079 10.6cm (4.17")



Iced Tea Spoon **NEW**  
SX006 19.0cm (7.48")



Childs Knife **NEW**  
SX032 16.1cm (6.34")



Childs Fork **NEW**  
SX033 15.1cm (5.94")



Serving Spoon **NEW**  
SX061 23.6cm (9.29")



Childs Spoon **NEW**  
SX034 13.2cm (5.2")



Serving Fork **NEW**  
SX072 23.5cm (9.25")

\* Indicates Bright stocked items.  
All Satin items in this range are non-stock.  
Stock - Lead time maximum 20 working days.  
Non stock - Lead time maximum 25 working days.



ROBERT WELCH  
**STEAK KNIVES™**

NEW RANGE



Manufactured from specially hardened stainless steel, the blades of these steak knives are designed to provide the finest possible cutting edge, time and time again.

\* Indicates stocked items.



**Radford Steak Knife** **NEW**  
5970SX056 24.9cm (9.8") Bright\*



**Signature Steak Knife Serrated\*** **NEW**  
5979SX009 25.0cm 12.0cm Blade



**Trafforia Steak Knife\*** **NEW**  
5972SX056 22.2cm (8.74")



**Ammonite Steak Knife** **NEW**  
5991SX056 24.0cm (9.45")



**Hidcote Steak Knife** **NEW**  
5999SX056 23.4cm (9.21")



**RW2 Steak Knife** **NEW**  
5978SX056 24.0cm (9.45") Bright  
6006SX056 24.0cm (9.45") Satin



**Arden Steak Knife** **NEW**  
5992SX056 24.0cm (9.45")



**Honeybourne Steak Knife** **NEW**  
5976SX056 24.2cm (9.53")



**Stanton Steak Knife** **NEW**  
5973SX056 23.7cm (9.33") Bright  
6007SX056 23.7cm (9.33") Satin



**Ashbury Steak Knife** **NEW**  
5993SX056 24.8cm (9.76")



**Iona Steak Knife** **NEW**  
6000SX056 23.7cm (9.33")



**Signature Steak Knife Serrated 4P** **NEW**  
5979SX083 29.5cm (11.61")



**Baguette Steak Knife** **NEW**  
5975SX056 24.6cm (9.69") Vintage  
5994SX056 24.6cm (9.69") Bright



**Kingham Steak Knife** **NEW**  
5974SX056 24.0cm (9.45")



**Signature Steak Knife Plain Edge** **NEW**  
5979SX085 25.0cm 12.0cm Blade  
**Signature Steak Knife Plain Edge 4P**  
5979SX084 29.5cm (11.61")



**Bourton Steak Knife** **NEW**  
5997SX056 24.0cm (9.45")



**Malvern Steak Knife** **NEW**  
5971SX056 24.5cm (9.65")



**Vista Steak Knife** **NEW**  
6009SX056 24.4cm (9.61")



**Bud Steak Knife** **NEW**  
5984SX056 25.5cm (10.04")



**Norton Steak Knife** **NEW**  
6004SX056 24.9cm (9.8")



**Warwick Steak Knife** **NEW**  
6010SX056 24.0cm (9.45")



**Delta Steak Knife** **NEW**  
5983SX056 23.6cm (9.29")



**Palm Steak Knife** **NEW**  
6005SX056 24.9cm (9.8")



**Westbury Steak Knife** **NEW**  
6011SX056 24.8cm (9.76")



**Radford Steak Knife** **NEW**  
5990SX056 24.9cm (9.8") Satin

\* Indicates stocked items.

Stock - Lead time maximum 20 working days. Non stock - Lead time maximum 25 working days.



ROBERT WELCH  
**TRATTORIA™**

NEW RANGE



A modern take on classic European bistro dining. The classic contemporary design makes Trattoria versatile and suited to both indoor and outdoor dining.

Finish: Bright  
 Gauge: N/A

\* Indicates stocked items.



Table Knife\* **NEW**  
SX042 22.8cm (8.98")



Soup Spoon\* **NEW**  
SX002 19.0cm (7.48")



Steak Knife\* **NEW**  
SX056 22.2cm (8.74")



Dessert Spoon\* **NEW**  
SX003 16.7cm (6.57")



Dessert Knife\* **NEW**  
SX051 19.7cm (7.76")



Teaspoon\* **NEW**  
SX007 13.6cm (5.35")



Table Fork\* **NEW**  
SX021 19.6cm (7.72")



US Teaspoon **NEW**  
SX001 16.7cm (6.57")



Dessert Fork\* **NEW**  
SX023 17.4cm (6.85")



Serving Spoon **NEW**  
SX061 22.2cm (8.74")

\* Indicates stocked items.

Stock - Lead time maximum 20 working days. Non stock - Lead time maximum 25 working days.



The Drift collection offers a range of presentation pieces. Designed to be both aesthetically unique and highly functional, all Drift items are made from 18/10 stainless steel.

\* Indicates stocked items.



Champagne Bucket\* **NEW**  
RW001 23.5 x 19.0 x 21.0cm



Champagne Bucket Large\* **NEW**  
RW002 28.0 x 21.5 x 23.0cm



Champagne Bucket Stand\* **NEW**  
RW003 28.0cm dia x 64.0cm (h)



Champagne Cooler, Grand S/S **NEW**  
RW020



Double Walled Wine Cooler\* **NEW**  
RW013 13.6 x 13.4 x 22.4cm (h)



Cake Stand\* **NEW**  
RW014 24.2 x 24.2 x 42.0cm (h)



Wine Coaster\* **NEW**  
RW004 13.5 x 13.5 x 3.5cm (h)

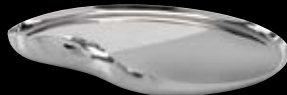

Serving Tray **NEW**  
RW005\* 36.0 x 32.0 x 4.0cm (h)  
RW019 25.0cm (w)  
RW018 20.0cm (w)



Condiment Servers Set\* **NEW**  
RW006 7.5 x 9.0 x 9.5cm (h)



Pinch Pot Set w/ Walnut Base\* **NEW**  
RW008 7.0 x 14.0 x 4.0cm (h)



Pinch Pot **NEW**  
RW007 6.6cm x 3.2cm (h)



Sugar Pot w/ Lid\* **NEW**  
RW012 300ml  
RW011 150ml



Sugar Pot **NEW**  
RW054 300ml  
RW053 150ml



Tea Strainer & Bowl **NEW**  
RW052



Bowl **NEW**  
RW089 30.0cm  
RW088 22.0cm  
RW087 15.0cm  
RW086 10.5cm



Teapot **NEW**  
RW010\* 900ml  
RW058 Lid 900ml  
RW009\* 450ml  
RW057 Lid 450ml



Jug\* **NEW**  
RW016 300ml  
RW015 150ml



Jug **NEW**  
RW017 2 Litre

\* Indicates stocked items.

Stock - Lead time maximum 20 working days. Non stock - Lead time maximum 25 working days.

Robert Welch.

ROBERT WELCH  
ACCESSORIES™

NEW RANGE



Robert Welch accent pieces provide the opportunity to create a warm and inviting atmosphere, which can transform the ambience from day to night. Either used as statement pieces or finishing touches to the tabletop, these accents offer flexibility, allowing you to create unique settings for each occasion.

All items in this range are non-stock.



**NEW**  
Limbrey Salt & Pepper Shakers  
5998RW034 15.0cm (5.91")



**NEW**  
Limbrey Salt Mill  
5998RW038 14.5cm (5.71")  
**NEW**  
Limbrey Pepper Mill  
5998RW031 14.5cm (5.71")



**NEW**  
Limbrey Salt Mill  
6001RW038 16.0cm (6.3")  
**NEW**  
Limbrey Pepper Mill  
6001RW031 16.0cm (6.3")



**NEW**  
Limbrey Bowl  
5998RW104 25.0cm  
5998RW103 12.5cm



**NEW**  
Limbrey Candlestick  
5998RW081 21.5cm (8.46")  
5998RW080 16.0cm (6.3")



**NEW**  
Arden Candleholder  
5992RW084 25.5cm (10")  
5992RW100 20.5cm (8")  
5992RW099 15.0cm (6")



**NEW**  
Windrush Candlestick  
6013RW080 16.0cm (6.3")



**NEW**  
Helix Hurricane Lamp  
6014RW082  
**NEW**  
Helix Tealight Holder  
6014RW102



**NEW**  
Drift Hurricane Lamp  
5977RW082 21.0cm (8.27")  
**NEW**  
Drift Tealight Holder  
5977RW101  
**NEW**  
Drift Candleholder  
5977RW083 4.0cm (1.57")



**NEW**  
Clove Tealight Holder  
5982RW023 70 x 125 x 40mm (h)

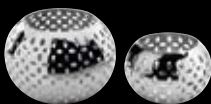

**NEW**  
Sesame Tealight Holder  
5981RW022A 88mm  
5981RW021A 55mm



**NEW**  
Drum Salt & Pepper Shakers 2P  
6012RW034



**NEW**  
Radford Napkin Ring Set 2P  
5970SX267 17.0cm (6.69")



**NEW**  
Vale Snuffer & Stand  
6016RW095



**NEW**  
Contour Steak Knife (4P Set)  
5986SX057



**NEW**  
L Pizza Knife  
6002SX319



**NEW**  
Young Diners Children  
Cutlery Set Green  
5980SX037

Robert Welch.

ROBERT WELCH  
SIGNATURE™

NEW RANGE



Designed with the aid of professional chefs and with comfort in mind, each knife has been purposefully designed for its specific task and diligently tested. These multi-award winning Signature knives and accessories are ergonomically shaped for maximum control and ease of use.

\* Indicates stocked items.



**Pepper Mill Black** NEW  
 SX089 31.2cm (12.28")  
 SX087 16.5cm (6.5")  
 SX088 11.4cm (4.5")



**Salt Mill White** NEW  
 SX299 16.5cm (6.5")  
 SX096 11.4cm (4.5")



**Black Utensil Stand** NEW  
 SX281A 33.4cm (13.15") h



**Non-Stick Server/Turner Large** NEW  
 SX090 32.0cm (12.6")



**Non-Stick Slotted Server/Turner Large** NEW  
 SX091 32.0cm (12.6")



**Ladle Large** NEW  
 SX063A 32.0cm (12.6")



**Ladle Small** NEW  
 SX065A 26.0cm (10.24")



**Slotted Drainer/Skimmer** NEW  
 SX097A 32.0cm (12.6")



**Pie/Flan Server** NEW  
 SX031 30.0cm (11.81")



**Rice Spoon** NEW  
 SX294 26.0cm (10.24")



**Serving Fork Large** NEW  
 SX072 33.0cm (12.99")



**Server/Turner Large** NEW  
 SX297 34.0cm (13.39")



**Server/Turner Small** NEW  
 SX081 30.0cm (11.81")



**Serving Spoon Deep Bowl** NEW  
 SX064A 32.0cm (12.6")



**Serving Spoon Small** NEW  
 SX066 26.0cm (10.24")



**Slotted Server/Turner Large** NEW  
 SX109 34.0cm (13.39")



**Slotted Spoon Deep Bowl** NEW  
 SX098 32.0cm (12.6")



**Spaghetti Server** NEW  
 SX082 32.0cm (12.6")

\* Indicates stocked items.  
 Stock - Lead time maximum 20 working days. Non stock - Lead time maximum 25 working days.





Cook/Chef Knife  
SX324 25.0cm (10") **NEW**



Cook/Chef Knife  
SX102 20.0cm (8") **NEW**



Cook/Chef Knife  
SX323 18.0cm (7.5") **NEW**



Cook/Chef Knife  
SX322 16.0cm (6.5") **NEW**



Cook/Chef Knife  
SX321 14.0cm (5.5") **NEW**



Cook/Chef Knife  
SX103 12.0cm (4.5") **NEW**



Deep Santoku Knife  
SX333 17.0cm (7") **NEW**



Santoku Knife  
SX330 17.0cm (7") **NEW**



Santoku Knife  
SX329 14.0cm (5.5") **NEW**



Santoku Knife  
SX328 11.0cm (4") **NEW**



Steak Knife Serrated\*  
SX009 12.0cm Blade **NEW**

Steak Knife Serrated 4P  
SX083 29.5cm (11.61") **NEW**



Steak Knife Plain Edge  
SX085 12.0cm Blade **NEW**

Steak Knife Plain Edge 4P  
SX084 29.5cm (11.61") **NEW**



Flexible Slicing Knife  
SX332 30.0cm (12") **NEW**



Bread Knife  
SX099 22.0cm (8.5") **NEW**



Flexible Fillet/Boning Knife **NEW**  
SX320 16.0cm (6.5")



Flexible Utility Knife **NEW**  
SX325 16.0cm (6.5")



Kitchen/Utility Knife **NEW**  
SX326 14.0cm (5.5")



Utility Knife Serrated **NEW**  
SX105 12.0cm (4.5")



Kitchen/Utility Knife **NEW**  
SX327 12.0cm (4.5")



Vegetable/Paring Knife **NEW**  
SX104 10.0cm (4")



Vegetable/Paring Knife **NEW**  
SX334 8.0cm (3")



Carving/Slicing Knife **NEW**  
SX100 23.0cm (9")



Carving Fork **NEW**  
SX101 18.0cm (7.5")



Carving Set Small **NEW**  
SX331

\* Indicates stocked items.

Stock - Lead time maximum 20 working days. Non stock - Lead time maximum 25 working days.



# GLASSWARE

Having the right glassware can be crucial to the overall dining experience. From defining the tabletop to enhancing a vintage bouquet, the importance of glassware cannot be underestimated.

- Wide selection of forms and shapes
- Improved resistance to impact damage
- Combines with all elements of the Steelite International range





# DRINIQUE

## Shatter your perceptions of glass.

What if your glassware didn't break? What if it didn't crack? And what if that glassware was guaranteed for life\*? Drinique drinkware is made from extraordinary Tritan™ Copolyester, even at 500 trips through a dishwasher this revolutionary material stays clear. Stack them without sticking, wash them without cracking, and even drop them without breaking; no matter the distress they continue looking good. All Drinique glasses are BPA free and made in the USA.

### \*LIFETIME BREAKAGE GUARANTEE

If any piece of Drinique drinkware ever breaks, cracks, or shatters under normal use, Drinique will replace that product free of charge, upon customer returning the product at their expense.

*Drinique*<sup>®</sup>  
DRINK UNIQUE



The Elite line of Drinique drinkware delivers sleek, elegant design and five-star quality. The tumblers stack without sticking, the champagne flute & wine glass elevate stemware to new heights; all with the look and feel of a glass.

Out with the old, in with the blue. Elite Blue's trendy design adds a splash of colour to your tabletop presentation. These sleek, five-star quality tumblers stack without sticking, wash without cracking, and even drop without breaking. Complete with a thick-walled carafe with a removable base for thorough cleaning, Drinique has proven to be the ideal drinkware for any dining experience.



Champagne/Martini Coupe  
7030DR029 23.65cl (8oz)



Shot Glass  
7030DR001 6.0cl (2oz)



Tumbler  
7030DR002 21.0cl (7oz)



Rocks Tumbler  
7030DR003 28.5cl (10oz)



HiBall Tumbler  
7030DR005 41.5cl (14oz)



Carafe  
7030DR007 85.0cl (28oz)



Champagne Flute  
7030DR008 17.0cl (6oz)



Stemmed Wine  
7030DR009 34.2cl (12oz)



Stemless Wine  
7030DR011 34.0cl (12oz)



Shot  
7032DR001 6.0cl (2oz)



Tumbler  
7032DR002 21.0cl (7oz)



Rocks Tumbler  
7032DR003 28.5cl (10oz)



HiBall Tumbler  
7032DR005 41.5cl (14oz)



Carafe  
7032DR007 85.0cl (28oz)



Champagne Flute  
7032DR008 17.0cl (6oz)



Stemmed Wine  
7032DR009 34.2cl (12oz)



Stemless Wine  
7032DR011 34.0cl (12oz)



Champagne/Martini Coupe  
7033DR029 23.65cl (8oz)

NEW



Champagne Flute  
7033DR008 17.0cl (6oz)



Stemmed Wine  
7033DR009 34.2cl (12oz)



Stemless Wine  
7033DR011 34.0cl (12oz)



Carafe Cap  
7034DR026 Blue  
7035DR026 Black



DRINIQUE  
**CALIBER™**

**NEW RANGE**

Caliber is the latest addition to the Drinique collection. Featuring sleek and contemporary glasses that offer great stackability, they're the perfect solution for outdoor beverage service. Designed for easy storage in tight spaces, these Tritan Copolyester glasses offer a lifetime guarantee against cracking, breakage, chipping or crazing.



Rocks **NEW**  
DR020 28.09cl (9½oz)



Double Rocks **NEW**  
DR021 35.48cl (12oz)



Pint (USA) **NEW**  
DR022 47.31cl (16oz)



Cooler **NEW**  
DR023 65.06cl (22oz)



# THRILL

THRILL  
VORTEX™

## NEW RANGE

A unique machine that not only sanitises in seconds, but keeps drinks cooler for longer without watering down the beverage or altering the flavour and aroma. Ever wondered why cocktails served in the trendiest bars taste so much better? The answer may not lie in the contents of the glass, but within the glass itself. A glass that has been cleaned and sanitised properly enhances the overall taste experience. The invisible residue that remains after washing may taint the taste and odour of drinks, compromising the quality of beverage served.

With THRILL, it takes just a few seconds to thoroughly sanitise and chill a glass, leaving it completely free of any unpleasant odours or aftertaste, giving customers the perfect serve and taste experience.

Stylish and theatrical, THRILL is a must have for upmarket bars and restaurants.



Countertop Glass Sanitiser S/S **NEW**  
6640TH001



Drop-In Glass Sanitiser S/S **NEW**  
6640TH002



## BUFFET SERVICE & PRESENTATION

An increasingly exciting dining occasion, buffet requires product which is versatile and elegant whilst retaining practicality. New and existing offers from Steelite International provide items which will maximise this opportunity and help create dynamic displays as well as offering exciting new twists on classic lines.





# CATHERINE HURAND

## Extraordinary glassware designed to impress

Catherine Hurand has been trained in the most prestigious Parisian schools of fine and decorative arts. A 1998 award winner for "Talents a la carte" for the decorative art salon "Maison et Objet," she has created services for many prestigious customers. Among them are notable Chefs Alain Ducasse and Georges Clemenceau.

A restaurateur will be sure to wow their guests with Catherine Hurand's beautiful and elegant glass collection. Adding instant glamour to the tabletop, these clear glass works of art will catch your eye every time. The unique designs will set any tabletop apart from the rest while expressing the true, artistic talent of its designer.



Catherine Hurand

## For a dining experience unlike the rest

- a large collection of unique shapes and sizes
- sophisticated in texture and a contemporary appeal
- perfect for signature dishes, buffet and display use

## Catherine Hurand

designed to enhance your imagination





CATHERINE HURAND

CERES™

NEW RANGE



Ceres is an assortment of unique and artistic glass bowls by designer Catherine Hurand. Perfect for sharing, serving, accents or centrepieces, Ceres is available in bold colours including Azure Blue and Indigo Blue, and subtle hues like Powder White and Smoked Grey. Ceres is high quality glass that can be utilized in many dining occasions.

Patterns Available





CATHERINE HURAND  
**CERES™**



**Bowl** **NEW**  
**6535B434** 26.03cm (10¼")  
 136.03cl (46oz)  
**6535B433** 21.91cm (8⅝")  
 68.01cl (23oz)  
**6535B432** 17.14cm (6¾")  
 35.48cl (12oz)



**Bowl** **NEW**  
**6536B434** 26.03cm (10¼")  
 136.03cl (46oz)  
**6536B433** 21.91cm (8⅝")  
 68.01cl (23oz)  
**6536B432** 17.14cm (6¾")  
 35.48cl (12oz)



**Bowl** **NEW**  
**6537B434** 26.03cm (10¼")  
 136.03cl (46oz)  
**6537B433** 21.91cm (8⅝")  
 68.01cl (23oz)  
**6537B432** 17.14cm (6¾")  
 35.48cl (12oz)

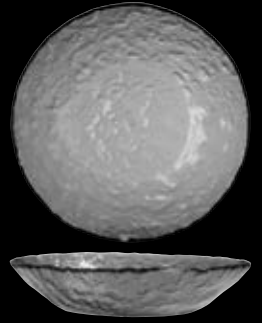

**Bowl** **NEW**  
**6529B434** 26.03cm (10¼")  
 136.03cl (46oz)  
**6529B433** 21.91cm (8⅝")  
 68.01cl (23oz)  
**6529B432** 17.14cm (6¾")  
 35.48cl (12oz)



CATHERINE HURAND  
**VENUS™**



**Venus Plate**  
**B421** 31.0cm x 19.0cm  
 (12¼" x 7½")



**Venus Plate**  
**B422** 25.0cm x 14.0cm  
 (9¾" x 5½")



**Venus Plate**  
**B423** 17.0cm x 11.0cm  
 (6¾" x 4⅜")



**Venus Plate**  
**B424** 12.0cm x 10.0cm  
 (4¾" x 4")



**Venus Bowl**  
**B425** 25.0cm x 21.0cm x 8.0cm  
 (9¾" x 8⅝" x 3⅛")  
 65.0cl (22oz)



**Venus Bowl**  
**B426** 10.0cm x 5.0cm  
 (4" x 2") 9.0cl (3oz)



**Venus Medium Round**  
**B427** 19.0cm x 20.0cm  
 (7½" x 7⅞")



**Venus Large Round Flat**  
**B428** 25.0cm x 26.0cm  
 (9⅞" x 10")



**Venus Long Linear**  
**B429** 39.0cm x 14.0cm  
 (15½" x 5½")



# CREATIONS GLASS

The Creations collection of contemporary glassware is designed to inspire and add impact to your tabletop. From the sparkle of clear glass to dramatic, coloured underliners and textured accent pieces, Creations allows you to use light and shade to stunning effect to exceed your guests' expectations.

**creati****ns**

BY STEELITE



### glorious glittering glassware

A dramatic collection of clear and coloured glass pieces which add variance and diversity to the tabletop. Hugely versatile, the pieces can be used across buffet presentations or as an alternative to traditional ceramic tableware.



**Gourmet Plate Medium Well**  
B445 27.0cm (10<sup>5</sup>/<sub>8</sub>"

NEW

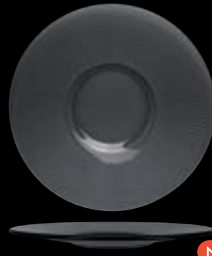

**Gourmet Plate Small Well**  
B446 27.5cm (10<sup>7</sup>/<sub>8</sub>"

NEW



**Gourmet Coupe Plate**  
B447 27.25cm (10<sup>3</sup>/<sub>4</sub>"

NEW



**Gourmet Rimmed Coupe Bowl**  
B448 27.25cm (10<sup>3</sup>/<sub>4</sub>"

NEW



**Gourmet Deep Coupe Bowl**  
B449 26.0cm (10<sup>1</sup>/<sub>4</sub>"

NEW



**Gourmet Deep Rimmed Bowl**  
B450 27.25cm (10<sup>3</sup>/<sub>4</sub>"

NEW

Due to the manufacturing process sizes may vary.

CLEAR: 6150

SMOKED: 6151



**Round Platter**  
G380 30.0cm (12")



**Round Platter**  
G379 25.0cm (10")



**Round Platter**  
G378 14.0cm (5<sup>1</sup>/<sub>2</sub>"



**Oval Platter**  
G381 40.0cm (16")

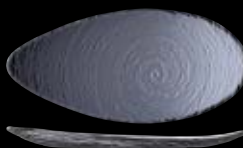

**Oval Platter**  
G382 30.0cm (12")

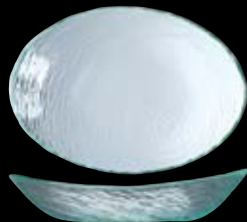

**Oval Bowl**  
G377 30.0cm (12")



**Oval Bowl**  
G376 20.0cm (8")



**Oval Bowl**  
G375 12.5cm (5")

CLEAR: 6512

SMOKED: 6513



CREATIONS  
**SHIKKU™**

**NEW RANGE**

**An exciting alternative to mainstream dinnerware**

Shikku glass is a sensational addition to the Creations portfolio. The pattern's linear shape and decoration exuberates an upscale, contemporary vibe, and provides a beautiful canvas for culinary creations. Shikku glass is an exciting alternative to mainstream porcelain dinnerware and adds an extra pop of colour to the tabletop.



**Rectangle Tray**  
6588B435 31.75cm x 19.0cm  
(12½" x 7½")

**NEW**

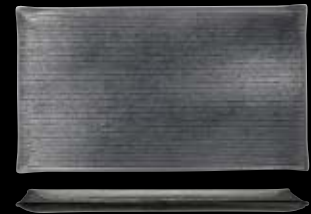

**Rectangle Tray**  
6588B436 27.0cm x 16.5cm  
(10⅝" x 6½")

**NEW**



**Square Tray**  
6588B437 26.67cm (10½")

**NEW**



**Square Tray**  
6588B438 16.5cm (6½")

**NEW**



**creations**  
BY STEELITE

CREATIONS **RIPPLE™**



**Ripple Glass Oval Platter**  
6506G334 26.0cm x 34.0cm  
(10¼" x 13½")



**Ripple Glass Bowl**  
6506G336 19.0cm (7½")  
6506G335 21.0cm (8¼")  
6506G337 26.0cm (10¼")  
6506G338 29.0cm (11½")

CREATIONS **ROCKPOOL™**

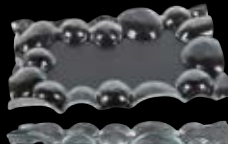

**Rockpool Rectangle**  
6527B563 30.0cm x 22.0cm  
(11¾" x 8½")

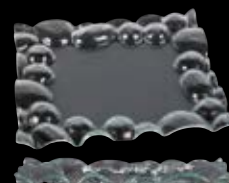

**Rockpool Square**  
6527B564 30.0cm (12")

CREATIONS **LUNA™**



**Luna Glass Bowl**  
6505G342 9.0cm (3½")



**Luna Glass Bowl**  
6505G340 13.0cm (5")



**Luna Glass Bowl**  
6505G339 18.0cm (7")



**Luna Glass Bowl**  
6505G343 23.0cm (9")

CREATIONS **POCKETS™**

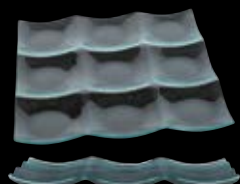

**Pockets Glass Square Plate**  
- 9 sections  
6506G344 32.0cm (12½")

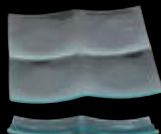

**Pockets Glass Square Plate**  
- 4 sections  
6506G345 20.0cm (8")

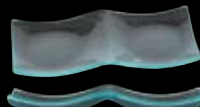

**Pockets Glass Rectangle Plate**  
- 2 sections  
6506G346 20.0cm x 10.0cm  
(8" x 4")

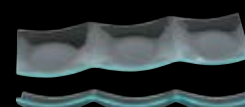

**Pockets Glass Rectangle Plate**  
- 3 sections  
6506G347 31.0cm x 10.0cm  
(12¼" x 4")



CREATIONS  
**SPLASH™**

Continually raising the bar for glass dinnerware presentation. Available in an assortment of shapes and sizes, Splash provides the perfect landscape for both bar service and sushi and seafood. A free flowing form, developed for a stunning presentation.



**Splash Rectangle Platter 4 Wells**  
6527B565 34.0cm x 10.0cm  
(13 1/4" x 4") 5.0cm (2") Wells



**Splash Rectangle Platter 3 Wells**  
6527B566 26.0cm x 10.0cm  
(10 1/4" x 4") 5.0cm (2") Wells

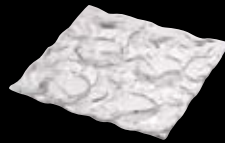

**Splash Square Platter 4 Wells**  
B567 22.0cm (8 1/2")  
5.0cm (2") Wells



**Splash Rectangle Platter**  
6527B568 24.0cm x 9.5cm  
(9 1/2" x 3 3/4")  
19.0cm x 5.0cm  
(7 1/2" x 2") Well



**Splash Square Platter**  
6527B569 21.0cm (8 1/4")



**Splash Rectangle Platter**  
6527B570 27.0cm x 12.0cm  
(10 5/8" x 4")



**creations**  
BY STEELITE

CREATIONS  
**BUBBLES™**

An elegant and irresistible presentation adds a new twist within Creations Glassware. Bubbles adds a fresh and crisp accent range, perfect for appetizers and small plates.



**Bubbles Square Plate**  
6532B420 12.7cm (5")



**Bubbles Rectangle Plate**  
6532B410 18.4cm x 11.8cm  
(7<sup>3</sup>/<sub>4</sub>" x 4<sup>1</sup>/<sub>2</sub>" )



**Bubbles Round Plate**  
6532B419 20.0cm (8")



CREATIONS GLASS



**Organics Glass Plate Clear**  
6527B710 36.0cm (14")



**Float**  
6506G244 28.0cm (11")  
Small Well 12.0cm (5")



**Red Border**  
6527B601 25.0cm x 25.0cm  
(10" x 10")



**Square Centred Tray**  
6506G203 30.0cm x 23.0cm  
(12" x 9")

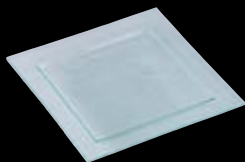

**Square Centred Plate**  
6506G213 25.0cm x 25.0cm  
(9 3/4" x 9 3/4")  
6506G217 30.0cm x 30.0cm  
(12" x 12")



**Square 9 Compartment Tray**  
6506G205 30.0cm x 30.0cm  
(12" x 12")



**Round Wide Rim Plate**  
6506G214 30.0cm (12")



**Butter Dish**  
6527B510 10.0cm x 10.0cm  
(4" x 4")



**Pearl Bowl Clear**  
6527B542 32.0cm (12 1/2")



**Curved Diamond**  
6506G227 18.0cm x 26.0cm  
(7" x 10 1/4")  
6506G228 21.0cm x 33.0cm  
(8 1/4" x 13")

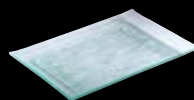

**Sushi Tray**  
6506G258 11.0cm x 25.0cm  
(4 1/4" x 10")  
6506G259 20.0cm x 28.0cm  
(8" x 11")

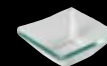

**Dip Dish**  
6527B673 9.0cm x 9.0cm  
(3 1/4" x 3 1/4")



**Rectangle Centred Tray**  
6506G202 30.0cm x 23.0cm  
(12" x 9")



**Rectangle 3 Compartment Tray**  
6506G201 30.0cm x 15.0cm  
(12" x 7")

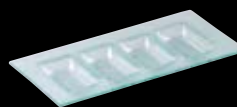

**Rectangle 4 Compartment Tray**  
6506G208 30.0cm x 15.0cm  
(12" x 7")



**Glass Rectangular Plate**  
6506G255 17.0cm x 32.0cm  
(6 1/2" x 12 1/2")  
6506G257 25.0cm x 40.0cm  
(10" x 15 1/2")



CREATIONS  
**ICE BUFFET™**

A stunningly unique approach to buffet presentation, Creations Ice Buffet adds a discernible value to any style of food presentation. With a textured surface, self contained sauce wells and optional stands, the modern appeal of Ice Buffet is sure to make a lasting impression.



**Oval Buffet Plate**  
6506G242 46.0cm x 19.0cm  
(18" x 7 1/2")



**Rectangular Divided Buffet Plate**  
6506G238 66.0cm x 28.0cm  
(26" x 11")



**Oval Buffet Plate**  
6506G239 66.0cm x 15.0cm  
(26" x 6")

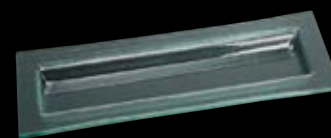

**1/1 Gastronorm Platter**  
6527B530 53.0cm x 32.5cm  
(21" x 12 1/2")

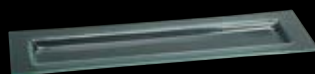

**2/4 Gastronorm Platter**  
6527B531 53.0cm x 16.0cm  
(21" x 6 1/4")



**Bridge Support**  
6503G062 20.0cm x 16.0cm  
(8" x 6 1/4")  
6503G063 12.0cm x 16.0cm  
(4 1/4" x 6 1/4")  
6503G070 7.5cm x 16.0cm  
(3" x 6 1/4")



### buffet presentation reaching new heights

Handcrafted in the USA, these beautifully unique, vertical stands are like no other! Utilising mixed mediums of industrial pipe and wood, these display stands offer height and mobility for visually pleasing presentations. Available in three distinct finishes, the pipe arms are moveable and can be adjusted for a variety of display options. Great for a multitude of uses from coffee & tea service to pastries and fruit smoothies to small appetizers, you can accessorise your display stand with an unlimited variety of small plates, cups, dishes, etc. that Steelite has to offer.



**Display Stand** NEW  
**6525T072** 35.5cm x 61.5cm (h)  
 (14" x 24 1/4" h)  
 Gun Metal Pipes  
 Chestnut Stain Wood



**Display Stand** NEW  
**6525T074** 35.5cm x 61.5cm (h)  
 (14" x 24 1/4" h)  
 Gun Metal Pipes  
 Ebony Stain Wood



**Display Stand** NEW  
**6525T073** 35.5cm x 61.5cm (h)  
 (14" x 24 1/4" h)  
 White Pipes  
 Weathered White Wood

**Wood Platform Dimensions:**  
 Base 35.5cm (14") x 1  
 Platform 25.5cm (10") x 2  
 Platform 20.25cm (8") x 2  
 Platform 15.25cm (6") x 1

Light Assembly Required



## elevate your presentation with seafood stands

Elevate your presentation with seafood stands by Williamsburg Metalworks. These unique, custom designed stands are made in the USA and provide versatility with their multi-tiered options. Made of highly durable, heavy gauge 18/8 stainless steel, these stands are easy to disassemble and are dishwasher safe. Bringing your presentations to new heights, it's the perfect solution for an impressive tabletop.



MIX & MATCH WITH

- Blue Dapple
- Ceres Glass
- Drinique Elite Blue



**NEW**

**Black Powder Coated 3-Tier Seafood Stand**  
**5856JX00** 31.0cm x 39.4cm (h)  
(12<sup>1</sup>/<sub>4</sub>" x 15<sup>1</sup>/<sub>2</sub>" h)

**W/Removable Drain Plates Straight Sided**

**Tier 1 - 30.5cm (12")**

**Tier 2 - 25.4cm (10")**

**Tier 3 - 20.3cm (8")**



**NEW**

**Black Powder Coated 2-Tier Seafood Stand**  
**5856JX01** 31.0cm x 23.0cm (h) (12<sup>1</sup>/<sub>4</sub>" x 9" h)

**W/Removable Drain Plates Straight Sided**

**Tier 1 - 30.5cm (12")**

**Tier 2 - 25.4cm (10")**



BUFFET SERVICE & PRESENTATION

OAK & FORD™ **NEW RANGE**



Supplying bespoke oak products to the hospitality industry. Based in Tamworth, Oak & Ford are a family business that has descendants from three generations of leather and wood craftsmen and furniture makers. Every product is made in their UK workshop by skilled craftsmen, using only the finest quality, premium grade materials, which are always from 100% sustainable sources.

There is a wide range of oak products to choose from, all of which can be adapted to suit your specific requirements. The collection offers many variants, allowing for different presentations and set ups, whether it's for breakfast, lunch or breakout areas.



**1/2 GN Shroud** NEW  
**6105OF01** 32.3 x 26.4 x 6.0cm  
 (12.72" x 10.39" x 2.36")



**1/1 GN Shroud** NEW  
**6105OF02** 52.9 x 32.3 x 6.0cm  
 (20.83" x 12.72" x 2.36")



**1/2 GN Lid** NEW  
**6105OF03** 32.3 x 26.4 x 4.0cm  
 (12.72" x 10.39" x 1.57")



**Oak & Steel Riser Spray Painted** NEW  
**6105OF10** 42 x 25 x 10.0cm  
 (16.54" x 9.84" x 3.94")



**Condiment Crate** NEW  
**6106OF06** 23.0 x 24.0 x 11.5cm  
 (9.06" x 9.45" x 4.53")



**Condiment Crate** NEW  
**6106OF07** 34.0 x 11.0 x 11.5cm  
 (13.39" x 4.33" x 4.53")



**Cutlery Holder** NEW  
**6106OF08** 38.0 x 14.0 x 12.0cm  
 (4.96" x 5.51" x 4.72")

**Oak Castle Chafer with Lift Off Lid 1/1 GN** NEW  
**5952CB15**

**Oak Castle Chafer with Hinged Lid 1/1 GN** NEW  
**5952CB16**



ROSELLI  
RISERS™



### **new culinary heights**

Ultra modern risers by Roselli Design will take your buffet and tabletop presentation to new heights. Bright white porcelain risers will elevate both sweet and savoury culinary presentations. Designed with form and function in mind, these works of art can also be used as a platform centrepiece.

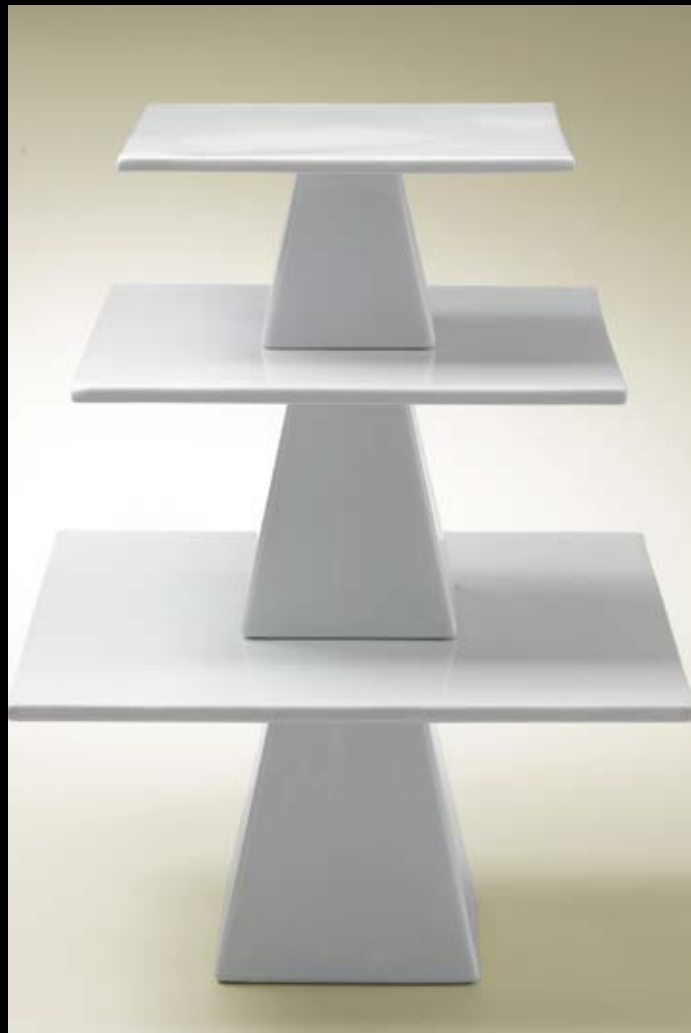
**Coupe**

- E700** Large 37.0cm (w) x 20.25cm (h)  
(14½" (w) x 8" (h))
- E701** Medium 29.0cm (w) x 16.5cm (h)  
(11½" (w) x 6½" (h))
- E702** Small 24.0cm (w) x 11.5cm (h)  
(9½" (w) x 4½" (h))

**Square**

- E703** Large 37.0cm (w) x 20.25cm (h)  
(14½" (w) x 8" (h))
- E704** Medium 29.0cm (w) x 16.5cm (h)  
(11½" (w) x 6½" (h))
- E705** Small 24.0cm (w) x 11.5cm (h)  
(9½" (w) x 4½" (h))

**Round**

- E706** Large 37.0cm (w) x 20.25cm (h)  
(14½" (w) x 8" (h))
- E707** Medium 29.0cm (w) x 16.5cm (h)  
(11½" (w) x 6½" (h))
- E708** Small 24.0cm (w) x 11.5cm (h)  
(9½" (w) x 4½" (h))



BUFFET SERVICE & PRESENTATION  
**CASTLE CHAFER™**



The new Chafers by Castle are a unique and energy efficient way of storing both wet and dry foods in food service. Whether it's breakfast or buffet service, storing hot or cold food, the Castle chafing dish will maintain your food at the perfect temperature to ensure that your customer is served your food exactly how you want.



1/1 GN Chafing Dish S/S  
5950CB01



1/2 GN Food Pan 80mm Deep S/S  
5950CB02



1/1 GN Food Pan 80 mm Deep S/S  
5950CB03

BUFFET SERVICE & PRESENTATION  
**CANYON CHAFERS™**



A passion for food is at the core of every event. Offering heating and cooling flexibility in a single unit, Canyon Chafers provide an exceptional return on investment, while maximising the visual aesthetic of your cuisine.



**Rectangular Canyon Chafing Dish  
Black with Black Steps**  
5400D100  
71.2cm x 50.8cm x 25.43cm  
(28" x 20" x 10")



**Rectangular Canyon Chafing Dish  
Black with Silver Steps**  
5400D101  
71.2cm x 50.8cm x 25.43cm  
(28" x 20" x 10")



**Rectangular Canyon Chafing Dish  
Black with Copper Steps**  
5400D102  
71.2cm x 50.8cm x 25.43cm  
(28" x 20" x 10")



**Rectangular Canyon Chafing Dish  
Silver with Silver Steps**  
5400D103  
71.2cm x 50.8cm x 25.43cm  
(28" x 20" x 10")



**Round Canyon Chafing Dish  
Black with Black Steps**  
5400D200  
60.96cm x 25.4cm  
(24" x 10")



**Round Canyon Chafing Dish  
Black with Silver Steps**  
5400D201  
60.96cm x 25.4cm  
(24" x 10")



**Round Canyon Chafing Dish  
Black with Copper Steps**  
5400D202  
60.96cm x 25.4cm  
(24" x 10")

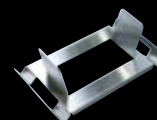

**Canyon Chafing Dish  
Lid Holder 5400D106**



**Vollrath Water Pan  
1/1 Rectangular**  
5399F100  
530mm x 325mm  
(21½" x 12½") 49331



**Vollrath Food Pan  
1/1 Rectangular**  
5399F104  
65mm Deep  
40022



**Vollrath Water Pan Round**  
5399F101  
350mm (13½")  
46488



**Vollrath Food Pan Round**  
5399F105  
65mm Deep  
46862

Also available  
**Vollrath Fuel Burner**  
5399F102 22.75cl (8oz)  
46864



# MELAMINE

Steelite International has further developed its offering of sourced products to bring exciting ranges of premium melamine displayware and dinnerware to the market. Responding to growing demand in the hospitality and retail markets for innovative display solutions Steelite International work with Southern Californian based partner company Elite Global Solutions to provide a stunning collection of outstanding quality melamine pieces.

Our Creations collections of products, available in various materials, from melamine to wood are designed by Steelite designers exclusively for Steelite International. These exclusive items can be identified by the Creations by Steelite backstamp which also identifies the origin source.

All our melamine dinnerware products are NSF & SGS approved chip and stain resistant, dishwasher safe and made to handle both hot and cold food.

**creati****ns**

BY STEELITE



Global Solutions



### fast casual melamine

Create a memorable presentation with Pompeii. This unique melamine dinnerware is great for fast casual dining and works well in any environment - from farm-to-table to Greek to Italian and more. With a lighter weight and higher durability than traditional tableware, Pompeii has a great price point and adds the perfect pop of colour to your tabletop.



Plate  
7194TM075 27.94cm (11") **NEW**



Plate  
7194TM074 22.86cm (9") **NEW**



Plate  
7194TM073 16.5cm (6½") **NEW**



Bowl  
7194TM072 23.81cm (9½")  
136.0cl (46oz) **NEW**



Bowl  
7194TM071 17.78cm (7")  
85.76cl (29oz) **NEW**



Bowl  
7194TM070 13.97cm (5½")  
37.7cl (12¾oz) **NEW**



Bowl  
7194TM069 9.52cm (3¾")  
14.78cl (5oz) **NEW**



Made from premium heavyweight melamine, these stylish and functional containers, designed by Steelite International are perfect for food displays or service. Ideal for both hot and cold food, these faux granite containers add interest and creativity to any table presentation.



GN 1/4 Salad Container **NEW**  
 68A607EL686  
 GN 1/4 Salad Container Lid  
 68A607EL687



GN 2/4 Salad Container **NEW**  
 68A607EL688 530 x 162 x 22.2mm  
 (21" x 6<sup>3</sup>/<sub>8</sub>")  
 GN 2/4 Salad Container Lid  
 68A607EL690



**creations**  
BY STEELITE

CREATIONS **MARBLE™** **NEW RANGE**



**GN 1/1 Rectangular Tray**  
68A600EL590 **NEW**  
530 x 325 x 22.2mm  
(21" x 12¾")



**GN 1/2 Rectangular Tray**  
68A600EL592 **NEW**  
325 x 265 x 22.2mm  
(12¾" x 10½")



**GN 1/3 Rectangular Tray**  
68A600EL594 **NEW**  
325 x 176 x 22.2mm  
(12¾" x 7")

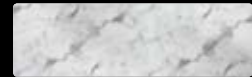

**GN 2/4 Rectangular Tray**  
68A600EL596 **NEW**  
530 x 162 x 22.2mm  
(21" x 6⅝")

CREATIONS **CONCRETE™** **NEW RANGE**



**GN 1/1 Rectangular Tray**  
68A601EL590 **NEW**  
530 x 325 x 22.2mm  
(21" x 12¾")



**GN 1/2 Rectangular Tray**  
68A601EL592 **NEW**  
325 x 265 x 22.2mm  
(12¾" x 10½")



**GN 1/3 Rectangular Tray**  
68A601EL594 **NEW**  
325 x 176 x 22.2mm  
(12¾" x 7")



**GN 2/4 Rectangular Tray**  
68A601EL596 **NEW**  
530 x 162 x 22.2mm  
(21" x 6⅝")

CREATIONS **SCAPE MELAMINE™**



**Plate**  
EL707 28.0cm Dia (11")



**Large Oval Platter**  
EL703 40.0cm x 24.2cm  
(16" x 9½")



**Large Oval Bowl**  
EL702 40.0 x 24.0 x 10.0cm H  
(16" x 9½" x 4")



**Plate**  
EL706 23.0cm Dia (9")



**Medium Deep Bowl**  
EL704 18.0cm x 7.8cm H  
(7" x 3")



**Small Deep Bowl**  
EL708 13.0cm x 5.3cm H  
(5" x 2")

The Scape range spans Performance, Creations Glassware and Melamine. For the full Melamine selection visit page 69.

WHITE: 68A451

PAPYRUS: 68A452

MUSHROOM: 68A453



CREATIONS CRAFT™

NEW ADDITIONS

The Craft range spans Performance and Melamine. For the full Melamine selection visit page 64.

creations  
BY STEELITE



Rectangle Platter 1/1  
68A416EL591  
530mm x 325mm (21" x 12¾")



Rectangle Platter 1/2  
68A416EL593  
325mm x 265mm (12¾" x 10½")



Rectangle Platter 1/3  
68A416EL595  
325mm x 176mm (12¾" x 7")



Rectangle Platter 2/4  
68A416EL597  
530mm x 162mm (21" x 6¾")



Plate Coupe **NEW**  
68A540EL043 25.4cm (10")  
68A540EL788 21.0cm (8¼")  
68A540EL318 16.2cm (6⅜")



Bowl **NEW**  
68A540EL574 21.3cm (8⅜")  
120.0cl (40½oz)  
68A540EL041 18.1cm (7⅛")  
70.0cl (23¾oz)  
68A540EL040 14.3cm (5⅝")  
41.0cl (13¾oz)

CREATIONS WHITE WASH™



GN 1/1 Rectangular Tray  
68A276EL590  
530 x 325 x 22.2mm (21" x 12¾")



GN 1/2 Rectangular Tray  
68A276EL592  
325 x 265 x 22.2mm (12¾" x 10½")



Rectangle Handled  
Serving Board  
68A276EL614 30.0cm x 18.0cm  
(11¾" x 7")  
68A276EL621 27.0cm x 14.0cm  
(10½" x 5½")



GN 1/3 Rectangular Tray  
68A276EL594  
325 x 176 x 22.2mm (12¾" x 7")



GN 2/4 Rectangular Tray  
68A276EL596  
530 x 162 x 22.2mm (21" x 6¾")



Square Platter  
68A276EL453 25.0cm (10")



Round Handled Serving Board  
68A276EL710 38.0cm dia (15")  
68A276EL709 34.0cm dia (13⅓")  
68A276EL608 30.0cm dia (11¾")  
68A276EL620 23.0cm dia (9")  
68A276EL619 18.0cm dia (7")



**creations**  
BY STEELITE

CREATIONS **SPIRAL**™



Rectangle Platter 1/1  
68A418EL591  
530mm x 325mm (21" x 12¾")



Rectangle Platter 1/2  
68A418EL593  
325mm x 265mm (12¾" x 10½")



Rectangle Platter 1/3  
68A418EL595  
325mm x 176mm (12¾" x 7")



Rectangle Platter 2/4  
68A418EL597  
530mm x 162mm (21" x 6⅝")

CREATIONS **WHITE**™



Rectangle Platter 1/1  
68A417EL591  
530mm x 325mm (21" x 12¾")



Rectangle Platter 1/2  
68A417EL593  
325mm x 265mm (12¾" x 10½")



Rectangle Platter 1/3  
68A417EL595  
325mm x 176mm (12¾" x 7")



Rectangle Platter 2/4  
68A417EL597  
530mm x 162mm (21" x 6⅝")

CREATIONS **STANDS**™



Gastronorm Narrow Stand  
68A414EL695 7.5cm x 8.3cm H  
(3" x 3¼")



Gastronorm Narrow Stand  
68A414EL696 7.5cm x 5.8cm H  
(3" x 2¼")



Gastronorm Stand  
68A414EL612 9.0cm (3½") H



Gastronorm Stand  
68A414EL613 5.7cm (2¼") H

CREATIONS **COVERS**™



Cover 1/1  
6470ML10 536 x 331 x 91.5mm  
(21" x 13" x 3½")



Cover 1/2  
6470ML11 331 x 271 x 91.5mm  
(13" x 10⅝" x 3½")



Cover 1/3  
6470ML12 331 x 182 x 91.5mm  
(13" x 7⅞" x 3½")



Cover 2/4  
6470ML13 536 x 168 x 91.5mm  
(21" x 6⅝" x 3½")



CREATIONS **SLATE**™

**creations**  
BY STEELITE



**Rectangle Platter 1/1**  
68A415EL591  
530mm x 325mm (21" x 12¾")



**Rectangle Platter 1/2**  
68A415EL593  
325mm x 265mm (12¾" x 10½")



**Rectangle Platter 1/3**  
68A415EL595  
325mm x 176mm (12¾" x 7")



**Rectangle Platter 2/4**  
68A415EL597  
530mm x 162mm (21" x 6⅜")



**Rectangular**  
68A358EL455 61.0 x 38.1 x 1.5cm  
(24" x 15" x ⅝" H)



**Rectangular**  
68A358EL454 50.8 x 25.4 x 1.5cm  
(20" x 10" x ⅝" H)



**Square**  
68A358EL453 25.4cm x 1.5cm  
(10" x ⅝" H)

CREATIONS **DRIFTWOOD**™



**Flat Tray 1/1**  
68A351EL590  
530mm x 325mm (21" x 12¾")



**Flat Tray 1/2**  
68A351EL592  
325mm x 265mm (12¾" x 10½")



**Flat Tray 1/3**  
68A351EL594  
325mm x 176mm (12¾" x 7")



**Flat Tray 2/4**  
68A351EL596  
530mm x 162mm (21" x 6⅜")



**Rectangle Serving Board**  
68A351EL621 27.0cm x 14.0cm  
(10½" x 5½")



**Rectangle Serving Board**  
68A351EL614 30.0cm x 18.0cm  
(11¾" x 7")



**Rectangular**  
68A351EL455 61.0 x 38.1 x 1.5cm  
(24" x 15" x ⅝" H)



**Rectangular**  
68A351EL454 50.8 x 25.4 x 1.5cm  
(20" x 10" x ⅝" H)

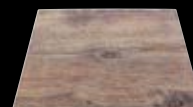

**Square**  
68A351EL453 25.4cm x 1.5cm  
(10" x ⅝" H)



**Round Serving Board**  
68A351EL710 38.0cm (15")  
68A351EL709 34.0cm (13⅓")  
68A351EL608 30.0cm dia (12" dia)  
68A351EL620 23.0cm dia (9" dia)  
68A351EL619 18.0cm dia (7" dia)



**creations**  
BY STEELITE

CREATIONS **FREEDOM MELAMINE™**



**Freedom Plate**  
EL677 25.0cm (10")



**Plate**  
EL668 23.0cm (9")



**Plate**  
EL667 16.5cm (6½")



**Bowl**  
EL669 20.3cm (8")

The Freedom range spans Performance and Melamine. For the full Melamine selection visit page 96.

BLUE: 68A534

YELLOW: 68A535

CREATIONS **DOME COVER™**



**Dome Cover**  
6471ML15 29.0cm (11½")

CREATIONS **BUFFET PLATE™**



**Buffet Plate**  
68A270EL617  
25.5cm x 19.5cm (10" x 7¾")



**White Combi Plate GN 1/3**  
68A270EL651  
325mm x 176mm (13¾" x 7")



**creations**  
BY STEELITE

CREATIONS **ZEST**™



**Platter**  
**68A430EL600**  
45.6cm x 38.2cm (18" x 15")



**Platter**  
**68A431EL600**  
45.6cm x 38.2cm (18" x 15")

CREATIONS **SCOOP**™



**Bowl**  
**68A420EL585**  
30.0cm x 23.6cm (11¾" x 9¼")



**Bowl**  
**68A420EL586**  
35.5cm x 27.5cm (14" x 10¾")



**Bowl**  
**68A420EL587**  
40.5cm x 31.4cm (16" x 12¼")



**Bowl**  
**68A421EL585**  
30.0cm x 23.6cm (11¾" x 9¼")



**Bowl**  
**68A421EL586**  
35.5cm x 27.5cm (14" x 10¾")



**Bowl**  
**68A421EL587**  
40.5cm x 31.4cm (16" x 12¼")

CREATIONS **SHEER**™



**Bowl**  
**68A425EL588**  
30.0cm x 14.0cm H (11¾" x 5½")



**Bowl**  
**68A425EL589**  
38.0cm x 17.5cm H (12" x 7")



**Bowl**  
**68A426EL588**  
30.0cm x 14.0cm H (11¾" x 5½")



**Bowl**  
**68A426EL589**  
38.0cm x 17.5cm H (12" x 7")



EGS KARMA™



**Two-Tone Sauce Dish**  
68A525EL711  
8.25 x 6.35 x 2.5cm h  
(3 1/4" x 2 1/2" x 1" h)



**Square Two-Tone Plate**  
68A525EL712  
12.7cm sq x 1.9cm  
(5" sq x 3/4" h)



**Rectangular Two-Tone Plate**  
68A525EL713  
23.0 x 12.7 x 2.5cm h  
(9" x 5" x 1" h)



**Rectangular Two-Tone Plate**  
68A525EL714  
33.0 x 20.0 x 2.5cm h  
(13" x 8" x 1" h)



**Chopsticks**  
68A380EL555  
27.0cm (10 1/2")



**Round Two-Tone Bowl**  
68A525EL715  
11.0cm x 6.4cm h  
(4 1/4" dia x 2 5/8" h)



**Round Two-Tone Bowl**  
68A525EL716  
23.0cm x 6.35cm h  
(9" dia x 2 1/2" h)



**Bento Box**  
68A525EL645  
28.0 x 21.6 x 5.0cm h  
(11" x 8 1/2" x 2" h)



**Lid for Bento Box**  
68A525EL672  
28.0 x 21.6 x 2.8cm h  
(11" x 8 1/2" x 1 1/8" h)



**Chopstick Rest**  
68A380EL717  
42.0mm dia

EGS ILLOGICAL™

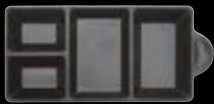

**4 Compartment Condiment Tray**  
68A065EL100 22.2 x 11.2 x 2.5cm  
(8 3/4" x 4 3/8" x 1" H)



**Sauce Bowl**  
68A065EL721 10.0cm x 3.8cm  
(4" Dia x 1 1/2" h)



**Frying Pan**  
68A065EL720 9.5cm x 3.8cm  
(3 3/4" Dia x 1 1/2" h)  
17.0cl (6oz)  
68A065EL719 8.25cm x 3.0cm  
(3 1/4" Dia x 1 1/4" h)  
11.3cl (4oz)  
68A065EL718 7.0cm x 2.5cm  
(2 3/4" Dia x 1" h)  
5.7cl (2oz)

EGS ARTIST SERIES™



**Square Bowl**  
6801EL005 33.0cm x 33.0cm (13" x 13")  
166.0cl (58oz)



**Square Platter**  
6801EL006 38.1cm x 38.1cm  
(15" x 15")



EGS **BELIZE**™



**Bowl**  
EL008 31.8cm (12½")  
639.0cl (225oz)



**Bowl**  
EL009 38.1cm x 17.4cm (15" x 7½")  
284.0cl (100oz)



BLACK: 6802

WHITE: 6803

TERRACOTTA: 6804

EGS **MODERNE**™



**Platter**  
6816EL029 40.0cm x 19.7cm  
(15¾" x 7¾")



**Bowl**  
EL031 20.3cm x 12.7cm (8" x 5")  
47.0cl (17oz)



**Bowl**  
EL096 30.5cm x 19.1cm (12" x 7½")  
213.0cl (75oz)

BLACK: 6816

WHITE: 6817

EGS **BILBAO**™



**Bowl**  
6805EL015 24.4cm x 22.9cm  
(9⅝" x 9")  
166.0cl (58oz)



**Bowl**  
6806EL016 24.4cm x 22.9cm  
(9⅝" x 9")  
166.0cl (58oz)

BLACK: 6805

WHITE: 6806

EGS **CRINKLED PAPER**™



**Bowl Square**  
EL017 25.4cm x 25.4cm  
(10") 142.0cl (50oz)



**Tray Square**  
EL019 30.5cm x 30.5cm  
(12" x 12")



**Tray Rectangle**  
6807EL018  
45.7cm x 29.2cm (18" x 11½")



**Tray Rectangle**  
6807EL022  
37.8cm x 17.5cm (14⅞" x 7⅝")

BLACK: 6807

WHITE: 6808



EGS TUSCANY™



**Square Bowl**  
6831EL070  
25.4cm x 25.4cm (10")  
166.0cl (58oz)



**Flared Round Bowl**  
6831EL071  
27.9cm (11")  
237.0cl (83oz)



**Round Bowl**  
6831EL073  
35.6cm (14")  
568.0cl (200oz)

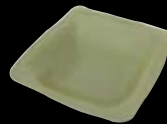

**Square Bowl**  
6833EL070  
25.4cm x 25.4cm (10")  
166.0cl (58oz)



**Flared Round Bowl**  
6833EL071  
27.9cm (11")  
237.0cl (83oz)



**Round Bowl**  
6833EL073  
35.6cm (14")  
568.0cl (200oz)

EGS PEBBLE CREEK™



**Bowl**  
6824EL040 14.3cm (5<sup>5</sup>/<sub>8</sub>")  
41.0cl (15oz)



**Bowl**  
6824EL041 18.1cm (7<sup>1</sup>/<sub>8</sub>")  
59.0cl (20oz)



**Bowl**  
6824EL042 24.8cm (9<sup>3</sup>/<sub>4</sub>")  
118.0cl (40oz)



**Plate**  
6824EL043 25.4cm (10")



**Bowl**  
6825EL040 14.3cm (5<sup>5</sup>/<sub>8</sub>")  
41.0cl (15oz)



**Bowl**  
6825EL041 18.1cm (7<sup>1</sup>/<sub>8</sub>")  
59.0cl (20oz)



**Bowl**  
6825EL042 24.8cm (9<sup>3</sup>/<sub>4</sub>")  
118.0cl (40oz)



**Bowl**  
6826EL040 14.3cm (5<sup>5</sup>/<sub>8</sub>")  
41.0cl (15oz)



**Bowl**  
6826EL041 18.1cm (7<sup>1</sup>/<sub>8</sub>")  
59.0cl (20oz)



**Bowl**  
6826EL042 24.8cm (9<sup>3</sup>/<sub>4</sub>")  
118.0cl (40oz)



**Bowl**  
6827EL040 14.3cm (5<sup>5</sup>/<sub>8</sub>")  
41.0cl (15oz)



**Bowl**  
6827EL041 18.1cm (7<sup>1</sup>/<sub>8</sub>")  
59.0cl (20oz)



**Bowl**  
6827EL042 24.8cm (9<sup>3</sup>/<sub>4</sub>")  
118.0cl (40oz)



**Round Plate**  
6827EL043 25.4cm (10")



## EGS HOT CHA CHA™



**Oval Platter**  
6841EL216  
32.4 x 22.2 x 3.2cm  
(12¾" x 8¾" x 1¼" H)



**Oval Platter**  
6841EL218  
37.7 x 29.6 x 3.2cm  
(14⅞" x 11⅝" x 1¼" H)



**Round Platter**  
6841EL343  
43.2cm x 4.7cm  
(17" x 1⅞" H)



**Large Round Platter**  
6841EL176  
47.6cm x 8.3cm  
(18¾" x 3¼" H)



**Round Plate**  
6841EL108  
22.9cm x 2.2cm  
(9" x 7⁄8" H)



**Round Plate**  
6841EL109  
30.5cm x 4.1cm  
(12" x 1⅝" H)



**Small Round Bowl**  
6841EL298  
18.8cm x 8.9cm  
(7⅝" x 3½" H)



**Round Bowl**  
6841EL103  
20.0cm x 6.0cm  
(8" x 2⅜" H)



**Round Bowl**  
6841EL301  
33.0cm x 8.6cm  
(13" x 3⅜")

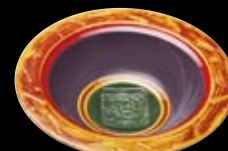

**Round Bowl**  
6841EL303  
37.2cm x 8.9cm  
(14⅝" x 3½" H)



## EGS FLAT TRAYS™



**Flat Tray**  
6811EL429 40.0 x 20.1 x 1.9cm  
(15¾" x 8" x ¾" H)



## EGS RUBBER PEDESTAL™



**Stand**  
6829EL058  
17.8 x 15.2 x 5.1cm  
(7" x 6" x 2")



**Stand**  
6829EL059  
17.8 x 15.2 x 7.6cm  
(7" x 6" x 3")

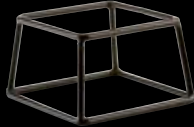

**Stand**  
6829EL060  
17.8 x 15.2 x 10.2cm  
(7" x 6" x 4")



**Stand**  
6829EL061  
17.8 x 15.2 x 12.7cm  
(7" x 6" x 5")



**Stand**  
6829EL062  
17.8 x 15.2 x 15.2cm  
(7" x 6" x 6")



**Stand**  
6829EL063  
17.8 x 15.2 x 17.8cm  
(7" x 6" x 7")



**Oval Stand**  
6829EL056  
35.5 x 28.2 x 6.3cm  
(14" x 11" x 2½")



**Oval Stand**  
6829EL057  
35.5 x 28.2 x 10.8cm  
(14" x 11" x 4¼")



**Round Stand**  
6829EL064  
15.2 x 17.8 x 5.1cm  
(6" x 7" x 2")



**Round Stand**  
6829EL065  
15.2 x 17.8 x 7.6cm  
(6" x 7" x 3")



**Round Stand**  
6829EL066  
15.2 x 17.8 x 10.2cm  
(6" x 7" x 4")



**Round Stand**  
6829EL067  
22.9 x 24.8 x 11.5cm  
(9" x 9¾" x 4½")

## EGS MUST HAVES™



**Ramekin**  
EL032 5.4cm (2⅛")  
3.0cl (1oz)



**Ramekin**  
EL033 6.6cm (2⅝")  
6.0cl (2oz)



**Ramekin**  
EL034 9.5cm (3¼")  
12.0cl (4oz)

BLACK: 6818

WHITE: 6819



EGS RISERS™



Pedestal for Round Top  
68A340EL567  
7.5cm (3" H)



Pedestal for Round Top  
68A340EL568  
12.7cm (5" H)



Pedestal for Round Top  
68A340EL569  
17.8cm (7" H)



Round Pedestal Top  
68A340EL566  
29.0cm (11½")



Pedestal for Square Top  
68A340EL426  
7.5cm (3" H)



Pedestal for Square Top  
68A340EL427  
12.7cm (5" H)



Pedestal for Square Top  
68A340EL428  
17.8cm (7" H)



Square Pedestal Top  
68A340EL425  
33.0cm (13")



EGS PUT ME ON A PEDESTAL™



White Cake Stand  
6800EL002  
33.0cm x 10.2cm (h) (13" x 4")



White Round Stand  
6800EL004  
36.8cm x 19.0cm (h) (14½" x 7½")



EGS **BAMBOO**™



**Rectangular**  
68A350EL455 61.0 x 38.1 x 1.5cm  
(24" x 15" x 5/8" H)



**Rectangular**  
68A350EL454 50.8 x 25.4 x 1.5cm  
(20" x 10" x 5/8" H)

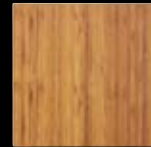

**Square**  
68A350EL453 25.4cm x 1.5cm  
(10" x 5/8" H)

EGS **TAG HOLDERS & CLIPS**™



**Spiral Sign Holder**  
68A374EL536 6.0cm x 7.6cm  
(2 3/8" x 3" h)



**Spiral Sign Holder**  
68A374EL537 6.0cm x 12.7cm  
(2 3/8" x 5" h)



**Ring Clip**  
68A375EL538 5.0cm x 10.2cm  
(2" x 4" h)



**Ring Clip**  
68A375EL539 5.0cm x 15.25cm  
(2" x 6" h)



**Clip-on Spring Sign Holder**  
68A373EL541 7.6cm x 10.16cm  
(3" x 4" h)



**Clip-on Spring Sign Holder**  
68A373EL542 7.6cm x 15.9cm  
(3" x 6 1/2" h)



**Double Clip-on Sign Holder**  
68A373EL549 9.5cm (3 3/4" h)



EGS FOUNDATIONS™



**Small White Utensil/Sauce Pot**  
6860EL524  
9.5cm H x 11.5cm dia  
(4 1/2" x 3 3/4") 45.0cl (16oz)



**Black Utensil/Sauce Pot**  
6861EL513  
14.0cm H x 11.5cm dia  
(5 1/2" x 4 1/2") 70.0cl (25oz)



**White Utensil/Sauce Pot**  
6860EL513  
14.0cm H x 11.5cm dia  
(5 1/2" x 4 1/2") 70.0cl (25oz)



**Black Ladle**  
6812EL553 25.0cm (10")



**Clear Ladle**  
68A376EL554 25.0cm (10")



**Black Scalloped Tong**  
6812EL540 (9 1/2")



**Clear Scalloped Tong**  
68A376EL540 (9 1/2")



**Solid Spoon**  
6812EL027 30.5cm (12")



**Solid Spoon**  
6813EL027 30.5cm (12")



**Solid Spoon**  
6814EL027 30.5cm (12")



**Solid Spoon**  
6815EL027 30.5cm (12")



**Slotted Spoon**  
6812EL028 30.5cm (12")



**Slotted Spoon**  
6813EL028 30.5cm (12")



**Slotted Spoon**  
6814EL028 30.5cm (12")



**Slotted Spoon**  
6815EL028 30.5cm (12")



EGS ZEN™



Spoon  
6835EL075 16.8cm (6<sup>5</sup>/<sub>8</sub>" )



Soup Spoon  
6835EL076 13.6cm (5<sup>3</sup>/<sub>8</sub>" )



Soup Spoon  
6835EL077 14.6cm (5<sup>3</sup>/<sub>4</sub>" )



Bowl  
6835EL078 24.8cm (9<sup>3</sup>/<sub>4</sub>" )  
118.0cl (41oz)



Bowl  
6835EL079 31.4cm (12<sup>3</sup>/<sub>8</sub>" )  
95.0cl (33oz)

Also available in black

PATTERN CODE: 6834



EGS ZEN™



**Bowl**  
6834EL143  
21.0cm x 8.0cm (7" x 3")  
83.0cl (29oz)



**Bowl**  
6835EL080  
18.1cm (7<sup>1</sup>/<sub>8</sub>") 101.0cl (35oz)



**Bowl**  
6835EL081  
24.1cm (9<sup>7</sup>/<sub>16</sub>") 95.0cl (33oz)



**3 Compartment Tray**  
6835EL082  
19.0cm x 8.0cm (7<sup>5</sup>/<sub>8</sub>" x 3<sup>1</sup>/<sub>4</sub>")



**Soup Bowl**  
6835EL083  
10.5cm (4<sup>1</sup>/<sub>8</sub>") 27.0cl (9oz)



**Lid**  
6835EL088  
9.3cm (3<sup>11</sup>/<sub>16</sub>")  
fits 6835EL083



**Plate**  
6835EL085  
25.7cm (10<sup>1</sup>/<sub>8</sub>")



**Platter**  
6835EL086  
31.1cm x 21.5cm  
(12<sup>1</sup>/<sub>4</sub>" x 8<sup>1</sup>/<sub>2</sub>")



**Platter**  
6835EL087  
37.8cm x 30.1cm  
(14<sup>7</sup>/<sub>8</sub>" x 11<sup>3</sup>/<sub>8</sub>")



**Tray Rectangle**  
6835EL084  
27.6cm x 11.7cm  
(10<sup>7</sup>/<sub>8</sub>" x 4<sup>5</sup>/<sub>8</sub>")



**Bowl**  
6835EL089  
11.4cm (4<sup>1</sup>/<sub>2</sub>") 24.0cl (8oz)



**Sauce Bowl**  
6835EL090  
11.4cm (4<sup>1</sup>/<sub>2</sub>") 18.0cl (6oz)



**Dish**  
6835EL091  
9.2cm x 7.0cm (3<sup>5</sup>/<sub>7</sub>" x 2<sup>3</sup>/<sub>4</sub>")  
5.0cl (1.75oz)



**2 Compartment Tray**  
6835EL092  
13.6cm x 8.5cm  
(5<sup>3</sup>/<sub>8</sub>" x 3<sup>3</sup>/<sub>8</sub>")



**Bowl**  
6835EL093  
9.5cm (3<sup>3</sup>/<sub>4</sub>") 12.0cl (4oz)



**Towel Plate**  
6835EL094  
16.9cm x 4.4cm (6<sup>11</sup>/<sub>16</sub>" x 1<sup>3</sup>/<sub>4</sub>")



**Tray Rectangle**  
6835EL095  
22.9cm x 9.5cm (9" x 3<sup>3</sup>/<sub>4</sub>")

Also available in black

PATTERN CODE: 6834

# Index

## A

Accessories ..... 98, 133, 188  
 Alison ..... 147  
 Alma ..... 112  
 Alumina Vitrified ..... 24  
 Alvo ..... 50  
 Anfora ..... 112  
 Antoinette ..... 44  
 Art Glaze ..... 106  
 Artist Series ..... 242  
 Aura ..... 130  
 Avina ..... 153  
 Axis ..... 39  
 Azure ..... 31

## B

Baguette ..... 164  
 Bamboo ..... 248  
 Belize ..... 243  
 Bianco ..... 52  
 Blue Dapple ..... 76  
 Bone China ..... 102  
 Bilbao ..... 243  
 Brown Dapple ..... 74  
 Bryce ..... 148  
 Bubbles ..... 215  
 Bud ..... 166  
 Buffet ..... 137  
 Buffet Plate ..... 240

## C

Café Porcelain ..... 140  
 Caliber ..... 200  
 Canyon Chafers ..... 228  
 Carnival ..... 95  
 Castle Chafer ..... 226  
 Catherine Hurand ..... 204  
 Ceres ..... 206  
 Charcoal Dapple ..... 72  
 Concrete ..... 236  
 Cookware ..... 90  
 Contour ..... 40  
 Covers ..... 238  
 Craft ..... 56  
 Craft (Melamine) ..... 64, 237  
 Craft Cookware ..... 62  
 Creations Glass ..... 101, 208  
 Creations Melamine ..... 232  
 Creations Wood ..... 98  
 Crinkled Paper ..... 243  
 Crucial Detail ..... 134  
 Cutlery ..... 142

## D

Display Stands ..... 218  
 Distinction ..... 26  
 Distressed Briar ..... 154  
 Dome Cover ..... 240  
 Drift ..... 186  
 Driftwood ..... 239  
 Drinique ..... 196

## E

Elite ..... 198  
 Elite Global Solutions ..... 242

## F

Flat Trays ..... 245  
 Float ..... 39  
 Folio ..... 144  
 Foundations ..... 249  
 Freedom ..... 96  
 Freedom (Melamine) ..... 97, 240  
 FreeStyle ..... 78  
 Fulton Vintage ..... 156  
 Fulton Vintage Copper ..... 155

## G

Glassware ..... 194  
 Granite ..... 234

## H

Hartman ..... 146  
 Honeybourne ..... 168  
 Hot Cha Cha ..... 245

## I

Ice Buffet ..... 217  
 Illogical ..... 242  
 Ink ..... 70

## J

Jean Dubost ..... 160

## K

Karma ..... 242  
 Kingham ..... 170  
 Koto ..... 42

## L

Laguiole ..... 160  
 Landscape ..... 138  
 LiV ..... 92  
 Luna ..... 213

## M

Malvern ..... 172  
 Marble ..... 236  
 Marnee ..... 152  
 Melamine ..... 230  
 Mist ..... 30  
 Moderne ..... 243  
 Monaco ..... 36  
 Must Haves ..... 246

## N

Neo ..... 40

## O

Oak & Ford ..... 222  
 Organics ..... 48  
 Origin ..... 157

## P

Parentheses ..... 139  
 Pebble Creek ..... 244  
 Performance ..... 54  
 Pier ..... 120  
 Pirouette ..... 149  
 Plateau ..... 136  
 Pockets ..... 213  
 Pompeii ..... 232  
 Porcelain ..... 116  
 The Potters Collection ..... 120  
 Puebla ..... 114  
 Put Me On A Pedestal ..... 247

## Q

Quadro ..... 40

## R

Radford ..... 174  
 Rene Ozorio ..... 122  
 Rio ..... 94  
 Ripple ..... 213  
 Risers ..... 247  
 Robert Gordon ..... 118  
 Robert Welch ..... 162  
 Rockpool ..... 213  
 Roselli Risers ..... 224  
 Royal Crown Derby ..... 104  
 Rubber Pedestal ..... 246  
 RW2 ..... 178

**S**

Scape ..... 66

Scape (Glass).....68, 211

Scape (Melamine)..... 69, 236

Scoop..... 241

Seafood Stands ..... 220

Sheer..... 40, 241

Slate..... 239

Shikku ..... 212

Signature ..... 190

Simplicity ..... 86

Simplicity Teapot Infuser ..... 89

Sonata..... 128

Spiral ..... 238

Splash ..... 214

Spyro..... 46

Stage..... 100

Stands ..... 238

Stanton..... 180

Steak Knives..... 158, 182

Stoneware.....110

Storm ..... 120

Studio Glaze ..... 108

**T**

Tag Holders & Clips ..... 248

Taste ..... 80

Taste Glass ..... 83

Taste Squares & Rectangles ... 82

Terramesa..... 84

Thrill ..... 201

Trattoria ..... 184

Tuscany ..... 244

**U**

Utensil/Sauce Pot..... 249

**V**

Varick..... 140, 150

Venus ..... 207

Vortex..... 201

**W**

Wabi Sabi ..... 124

White ..... 238

White Wash..... 237

Williamsburg Metalworks..... 220











Willow ..... 28

Willow (Glass) ..... 34, 211

**Z**

Zen ..... 250

Zest..... 241

Distinction	
Performance	
Accessories	
Bone China	
Porcelain	
Stoneware	
Cutlery	
Glassware	
Buffet Service & Presentation	
Melamine	









**United Kingdom & Republic of Ireland**

Steelite International Ltd  
Orme Street  
Stoke-on-Trent  
ST6 3RB  
England

**UK Distribution Centre**

Steelite International Ltd  
Station Street  
Stoke-on-Trent  
ST6 4NB  
England

Telephone +44 (0)1782 821 000  
Fax +44 (0)1782 819 926  
Email [headoffice@steelite.com](mailto:headoffice@steelite.com)

**London Showroom**

Steelite International Ltd  
75 Wells Street  
2nd Floor South  
London  
W1T 3QH  
Telephone +44 (0)1782 249 599  
Email [london@steelite.com](mailto:london@steelite.com)

**Continental Europe**

Telephone +44 (0)1782 829 347  
Fax +44 (0)1782 829 484  
Email [c.europe@steelite.com](mailto:c.europe@steelite.com)

**Benelux**

Steelite International Benelux BV  
's Gravelandseweg 258  
3125 BK Schiedam  
Nederland  
Telephone +31 (0)20 617 5915  
Email [info@steelite.nl](mailto:info@steelite.nl)

**Germany**

Steelite International  
Deutschland GmbH  
Philipp-Reis-Straße 16  
64404 Bickenbach  
Telephone +49 (0)6257 61950  
Fax +49 (0)6257 7944  
Email [germany@steelite.com](mailto:germany@steelite.com)

**France**

Telephone +33 6 8257 4291  
Email [france@steelite.com](mailto:france@steelite.com)

**Scandinavia**

Telephone 0031 624 212 506  
Email [scandinavia@steelite.com](mailto:scandinavia@steelite.com)

**Italy**

Telephone +39 0522 902051  
Fax +39 0522 902017  
Email [italy@steelite.com](mailto:italy@steelite.com)

**Spain**

Steelite International Spain  
C/General Espartero 18  
03012 Alicante  
Telephone +34 966 590 300  
Fax +34 965 990 701  
Email [spain@steelite.com](mailto:spain@steelite.com)

**Portugal**

Telephone +351 918 550 429  
Fax +351 211 541 022  
Email [info@steeliteportugal.com](mailto:info@steeliteportugal.com)

**Russia, Central & Eastern Europe**

The Central Europe Consultancy  
2nd Floor  
3 Rosemont Road  
London  
NW3 6NG  
Tel 0044 207 435 9033  
Mob 00777 613 5088  
Email [rcee@steelite.com](mailto:rcee@steelite.com)

**Australia**

Steelite International  
Unit 45  
Slough Business Park  
2 Slough Avenue  
Silverwater  
NSW 2128  
Telephone +61 (0)2 9648 4522  
Fax +61 (0)2 9648 4523  
Email [australia@steelite.com](mailto:australia@steelite.com)

**Canada**

Steelite International Canada Ltd  
Unit 2  
26 Riviera Drive  
Markham  
Ontario  
L3R5M1  
Telephone +1 905 752 1074  
Fax +1 905 752 1120  
Email [canada@steelite.com](mailto:canada@steelite.com)

**Middle East**

Steelite International Middle East  
A Ronai LLC  
PO Box 115944  
Dubai  
United Arab Emirates  
Telephone +9714 341 4409  
Fax +9714 341 4457  
Email [mea@steelite.com](mailto:mea@steelite.com)

**Asia**

Telephone +601 2347 9703  
Fax +44 (0)1782 821 000  
Email [asia@steelite.com](mailto:asia@steelite.com)

**United States of America**

Steelite International USA Inc  
154 Keystone Drive  
New Castle  
PA 16105  
Telephone +1724 856 4900  
Fax +1724 856 7924  
Email [usa@steelite.com](mailto:usa@steelite.com)

**www.steelite.com**

[facebook.com/steeliteinternational](https://facebook.com/steeliteinternational)

[twitter.com/steeliteUK](https://twitter.com/steeliteUK)

[instagram.com/steeliteint](https://instagram.com/steeliteint)

2000L313





[www.steelite.com](http://www.steelite.com)

 [facebook.com/steeliteinternational](https://facebook.com/steeliteinternational)

 [twitter.com/steeliteUK](https://twitter.com/steeliteUK)

 [instagram.com/steeliteint](https://instagram.com/steeliteint)

2000L313

